

Assorted Patterns

Photo: page 6

- The numbers represent the color numbers for DMC No. 25 embroidery floss
- The numbers in ○ represent the number of strands of thread
- Wrap French knots twice, unless otherwise noted

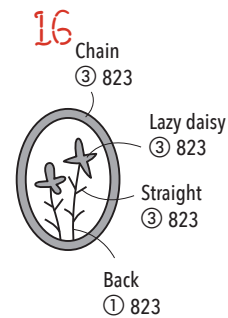
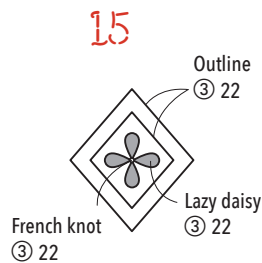
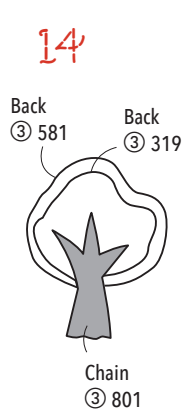
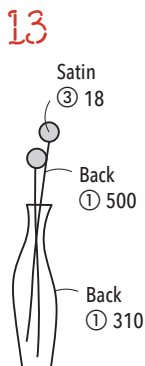
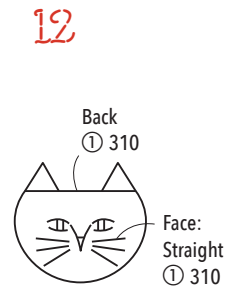
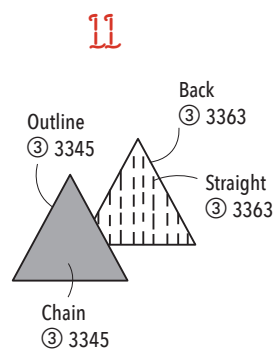
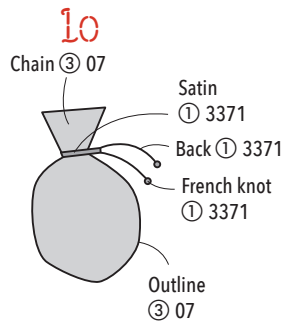
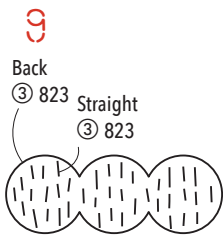
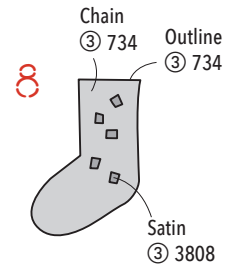
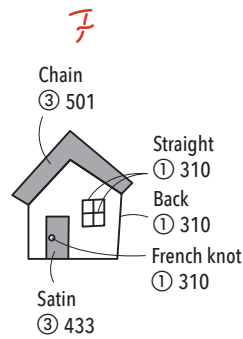
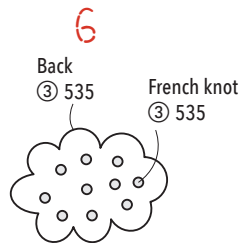
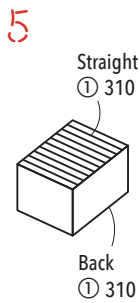
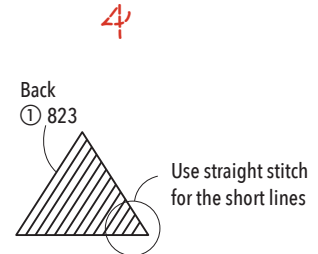
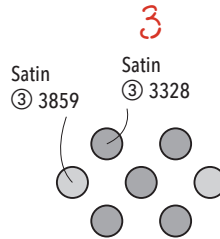
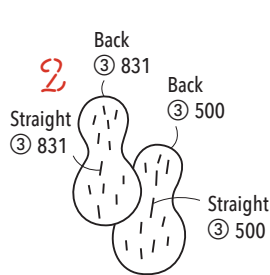
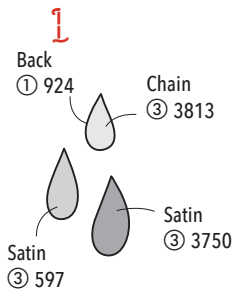

1



2

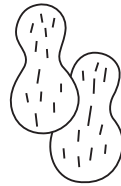

3

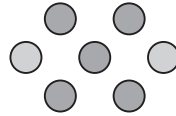

4

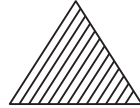

5

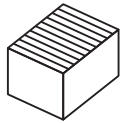

6

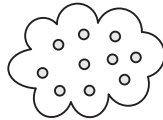

7



8



9

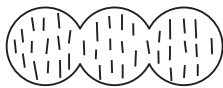

10

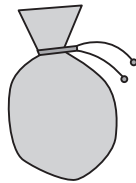

11

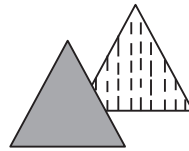

12



13



14



15



16



Simple Flowers

Photo: page 7

- The numbers represent the color numbers for DMC No. 25 embroidery floss
- The numbers in ○ represent the number of strands of thread
- Wrap French knots twice, unless otherwise noted

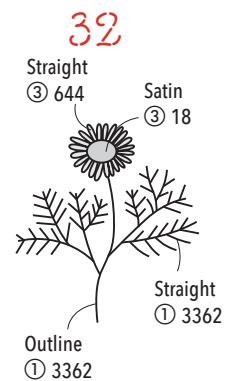
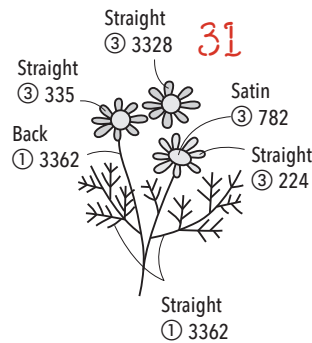
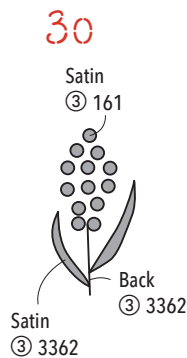
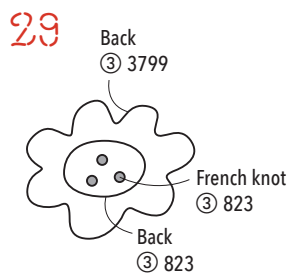
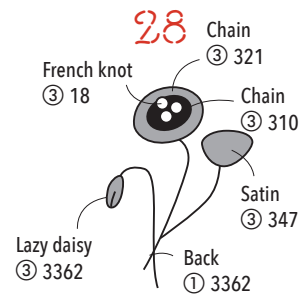
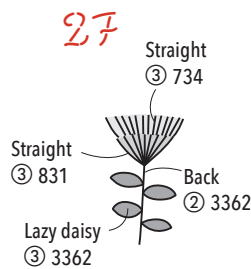
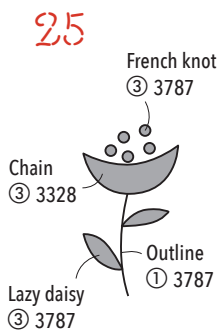
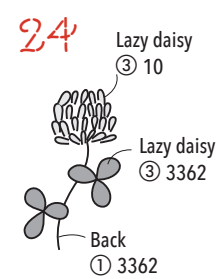
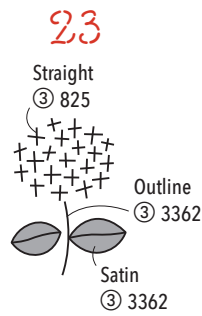
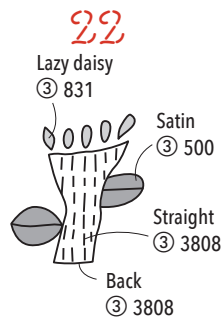
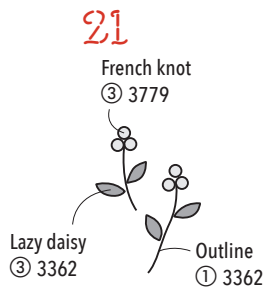
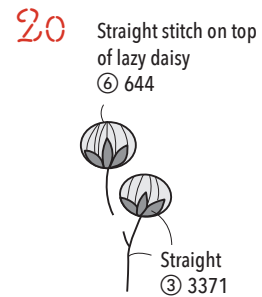
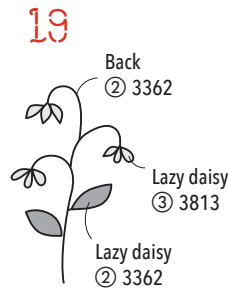
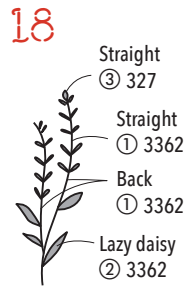
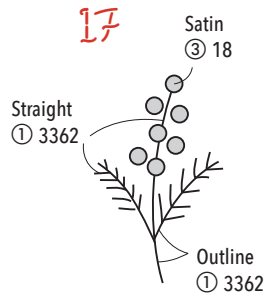

17



18



19



20



21



22

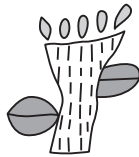

23

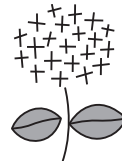

24



25



26



27



28



29

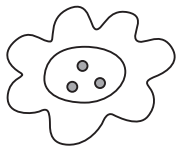

30



31



32



Folk Art Flowers

Photo: page 8

- The numbers represent the color numbers for DMC No. 25 embroidery floss
- The numbers in ○ represent the number of strands of thread
- Wrap French knots twice, unless otherwise noted

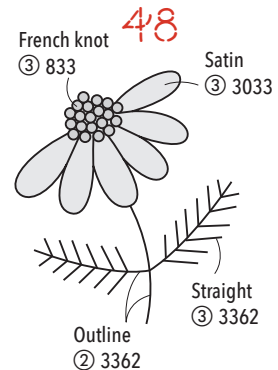
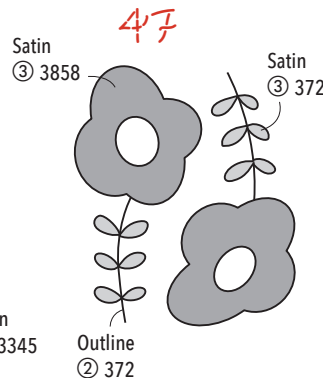
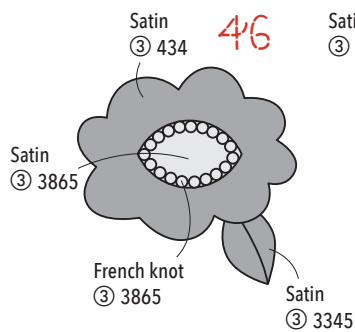
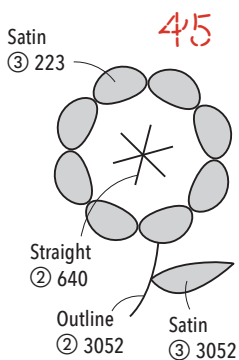
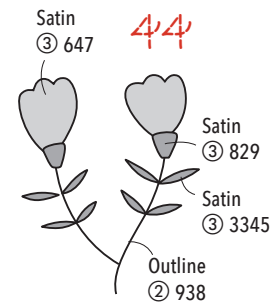
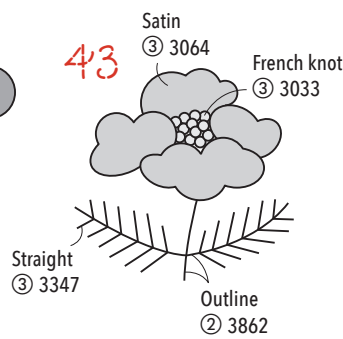
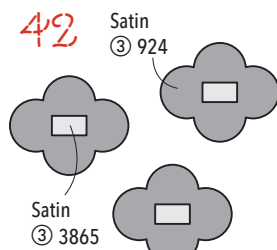
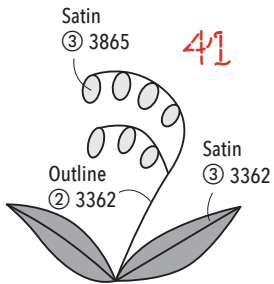
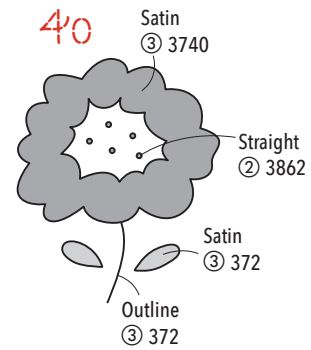
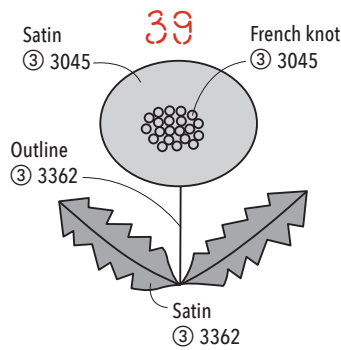
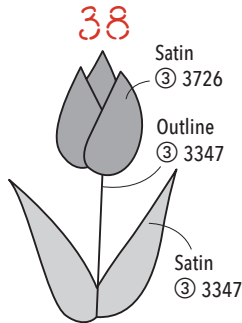
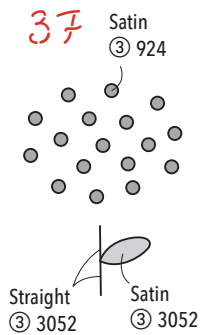
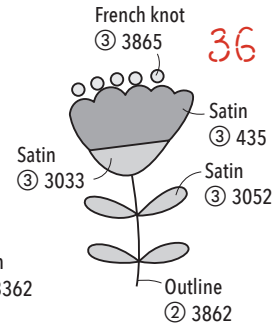
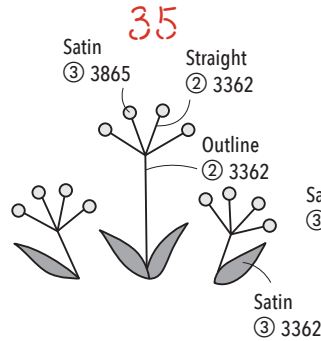
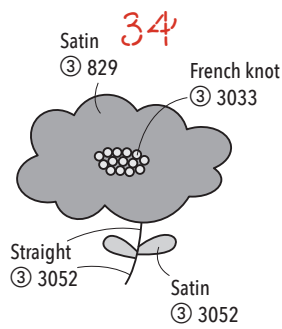
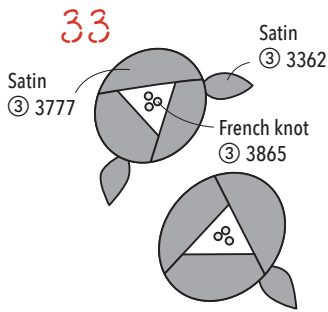

33

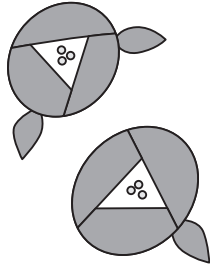

34

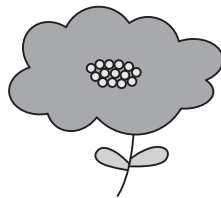

35

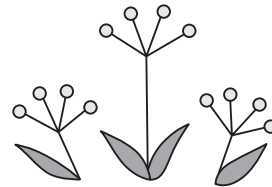

36



37

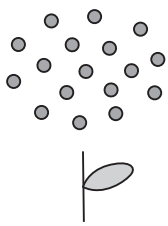

38

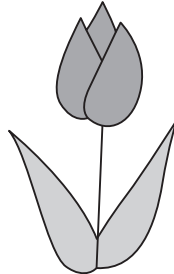

39

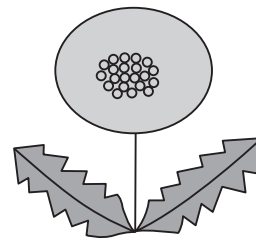

40



41

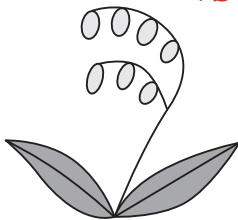

42

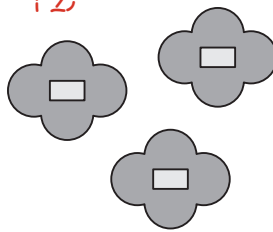

43

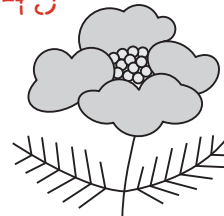

44

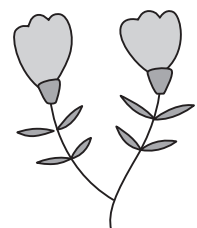

45

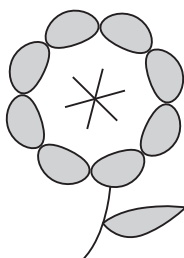

46

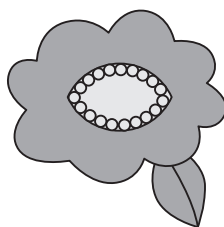

47

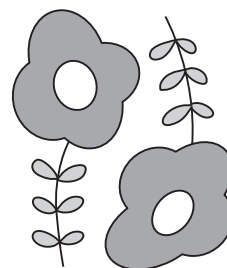

48

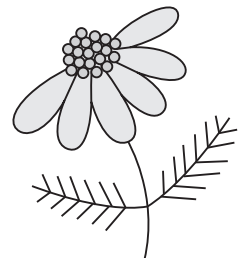

Folk Art Flowers

Photo: page 9

- The numbers represent the color numbers for DMC No. 25 embroidery floss
- The numbers in ○ represent the number of strands of thread
- Wrap French knots twice, unless otherwise noted

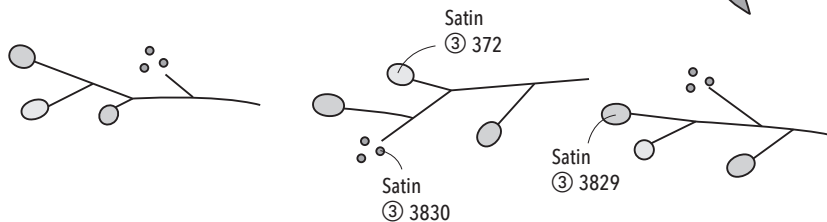
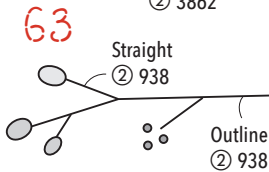
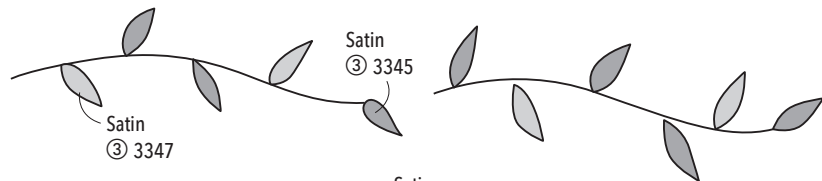
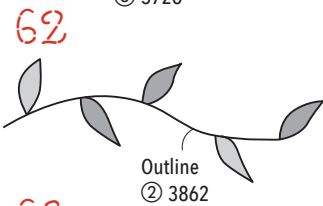
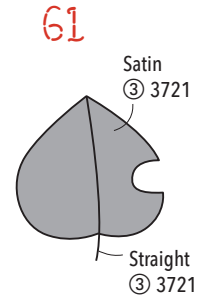
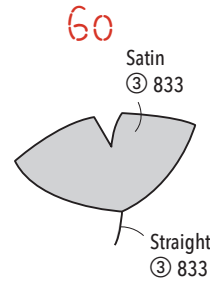
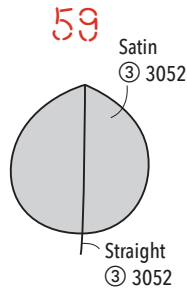
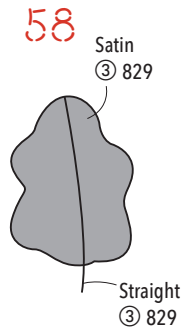
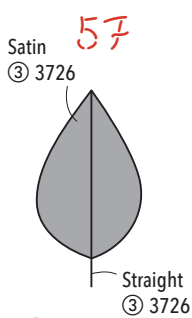
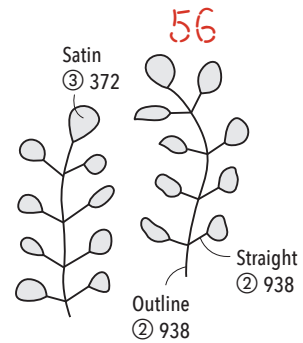
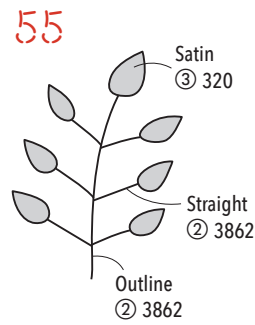
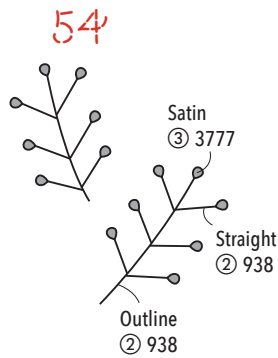
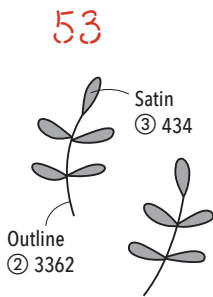
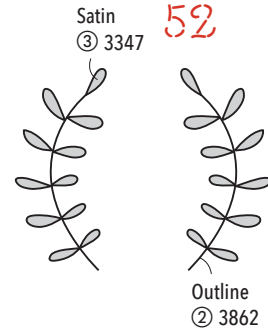
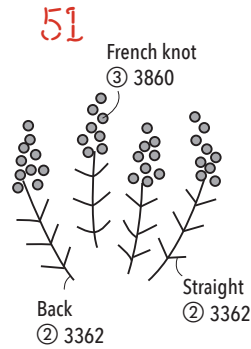
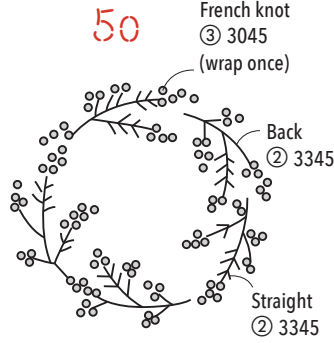
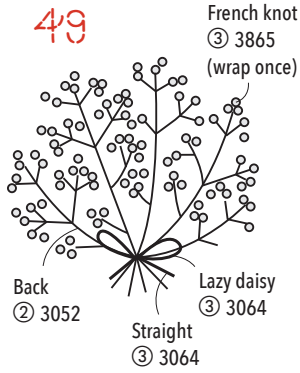

49

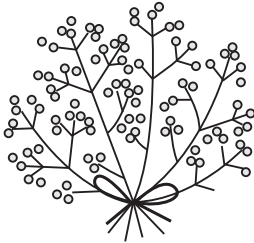

50

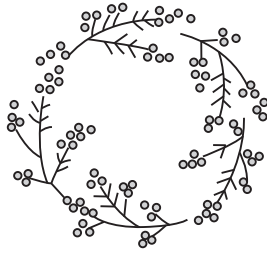

51

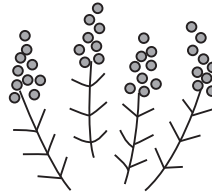

52

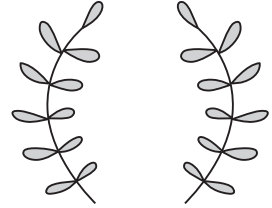

53

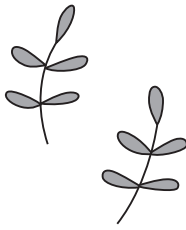

54

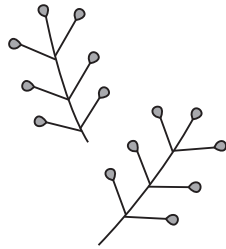

55

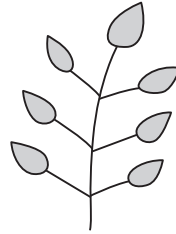

56

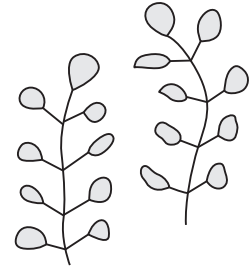

57

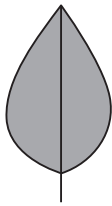

58



59

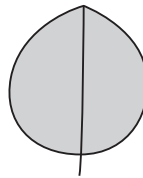

60

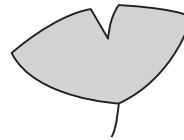

61

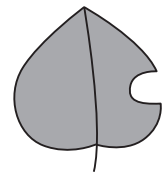

62

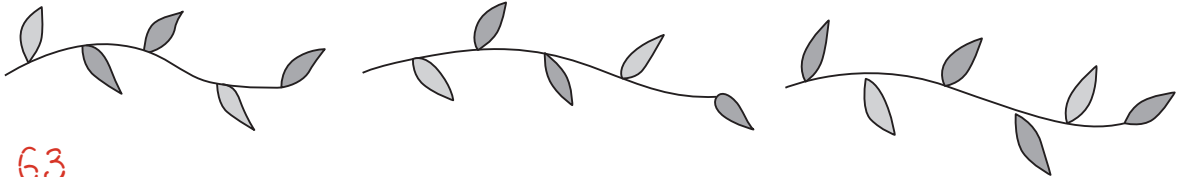

63

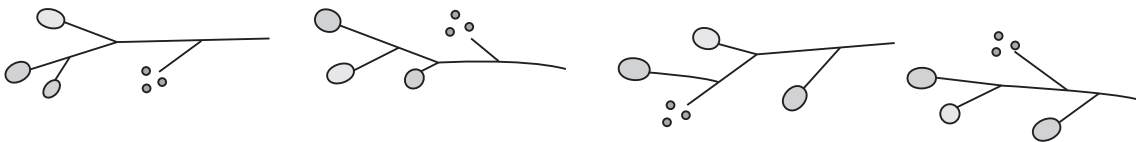

Fairytale Flowers

Photo: page 10

- The numbers represent the color numbers for Olympus No. 25 embroidery floss
- The numbers in ○ represent the number of strands of thread
- Wrap French knots twice, unless otherwise noted

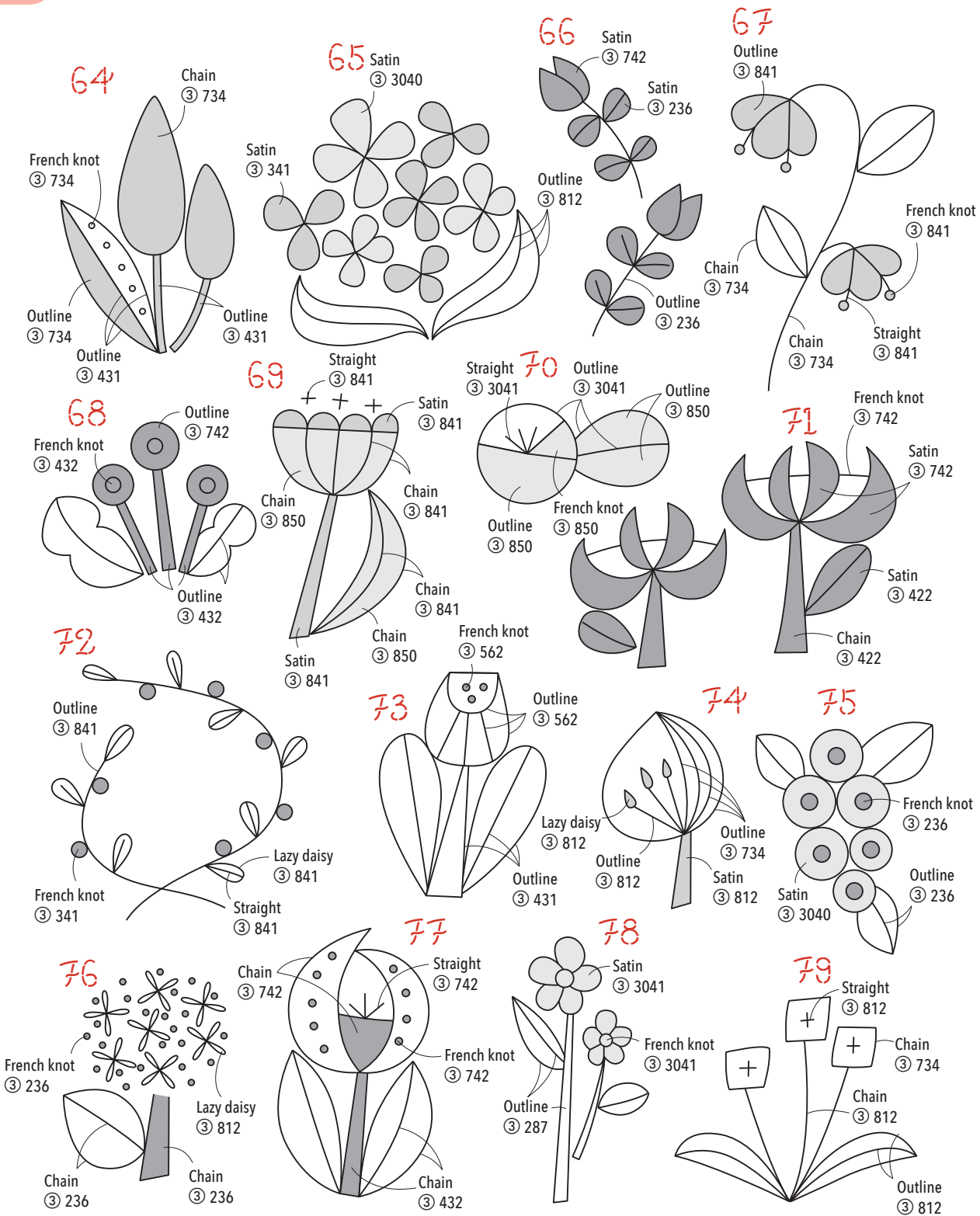

64

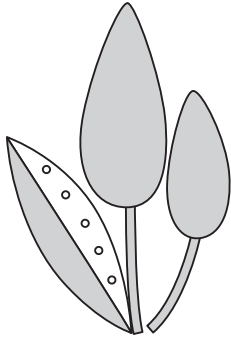

65

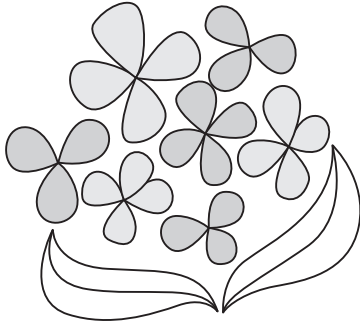

66

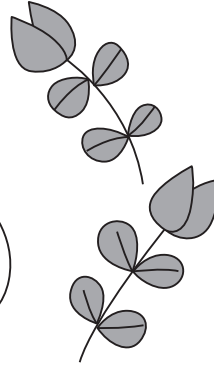

67

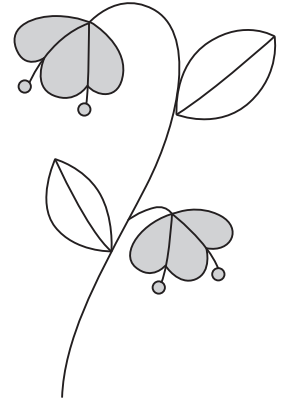

68

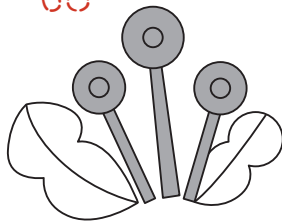

69

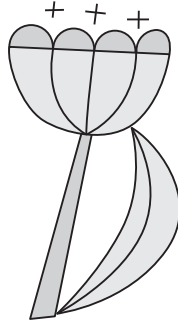

70

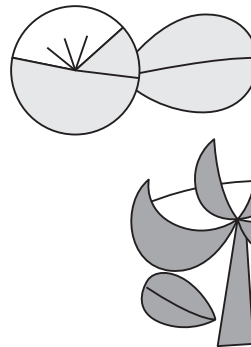

71

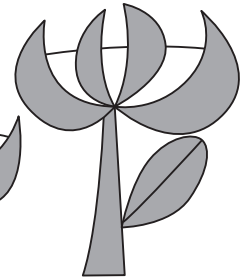

72

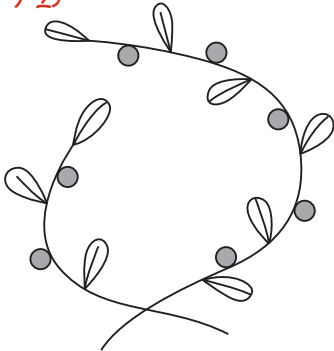

73

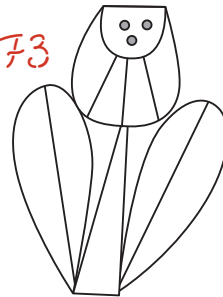

74

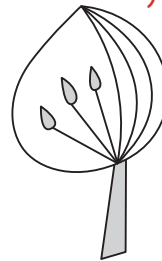

75

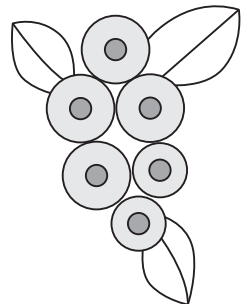

76

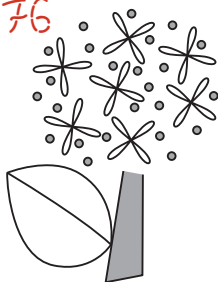

77

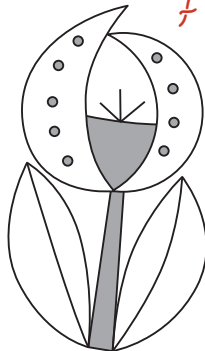

78

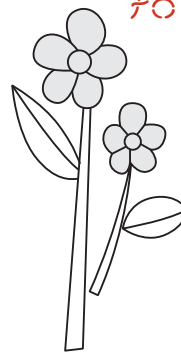

79

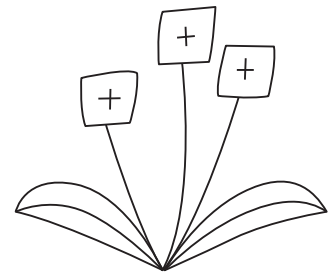

Fairytale Flowers

Photo: page 11

- The numbers represent the color numbers for Olympus No. 25 embroidery floss
- The numbers in ○ represent the number of strands of thread
- Wrap French knots twice, unless otherwise noted

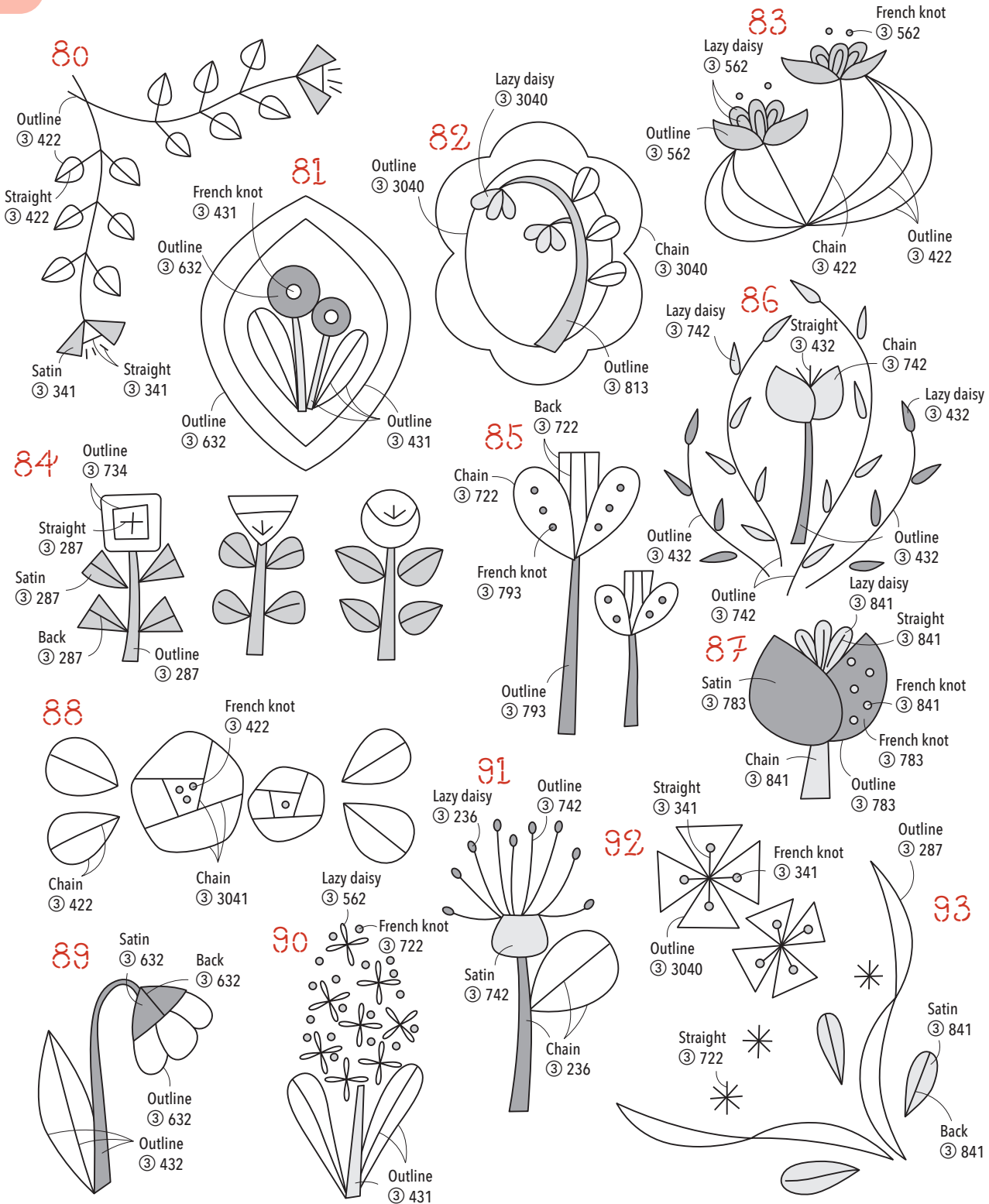

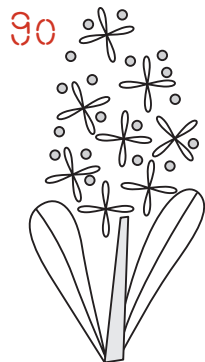
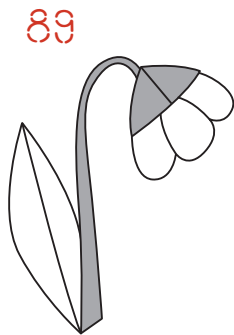
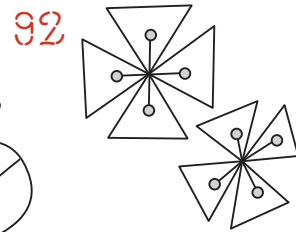
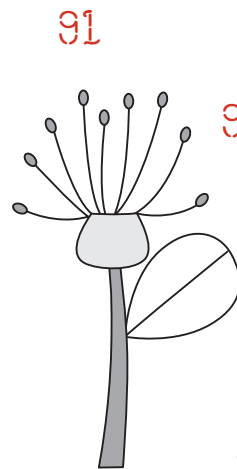
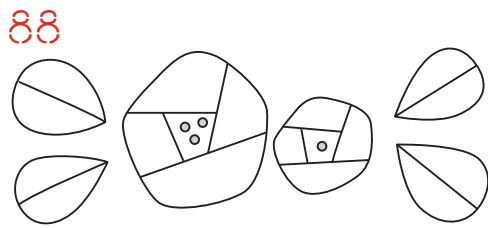
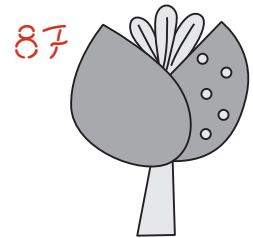
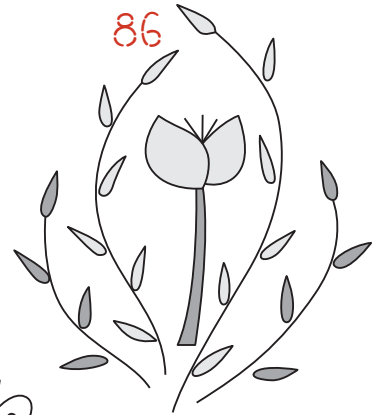
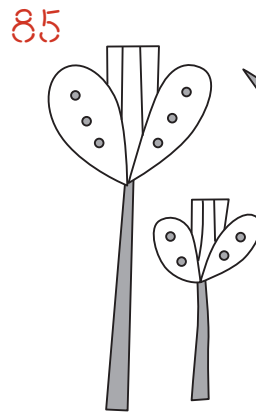
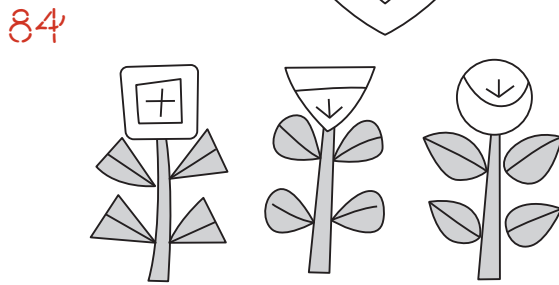
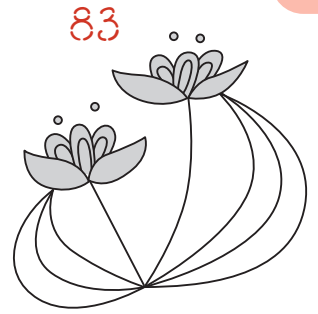
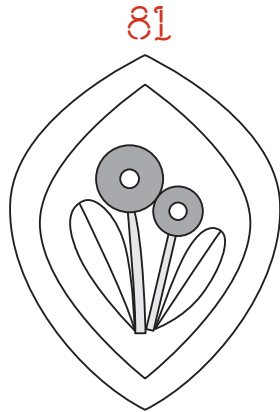
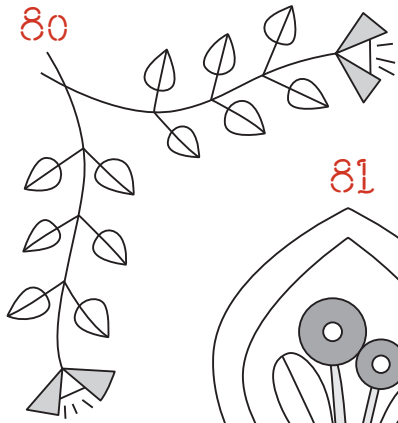

Breakfast Foods

Photo: page 12

- The numbers represent the color numbers for DMC No. 25 embroidery floss
- The numbers in ○ represent the number of strands of thread
- Wrap French knots twice, unless otherwise noted

94

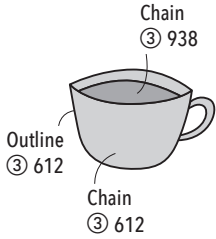

95

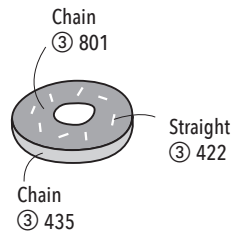

96

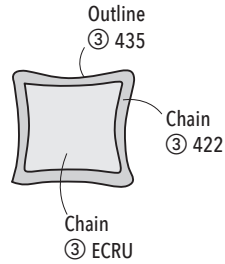

97



98

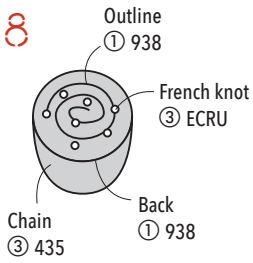

99

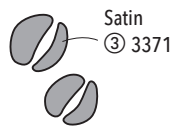

100

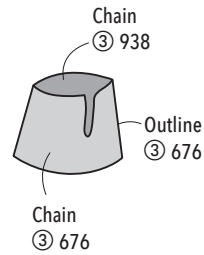

101



102

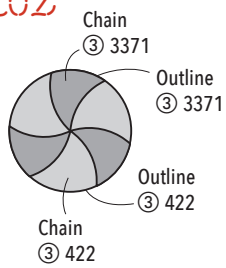

103

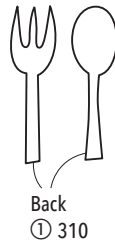

104

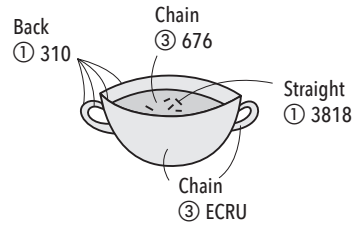

105

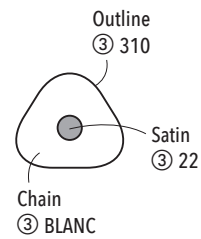

106

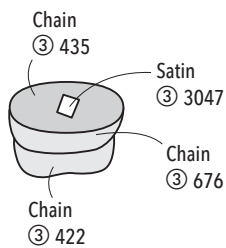

107

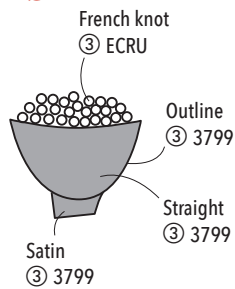

108

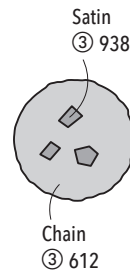

109

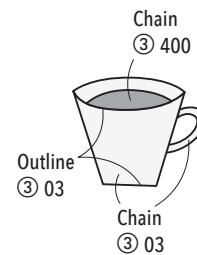

94



95

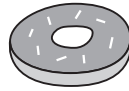

96

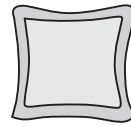

97



98

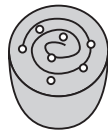

99



100

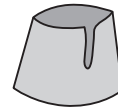

101



102

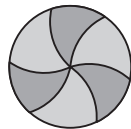

103



104



105

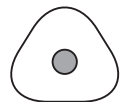

106

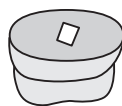

107



108

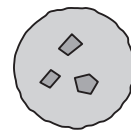

109



Fruits & Vegetables

Photo: page 13

- The numbers represent the color numbers for DMC No. 25 embroidery floss
- The numbers in ○ represent the number of strands of thread
- Wrap French knots twice, unless otherwise noted

110

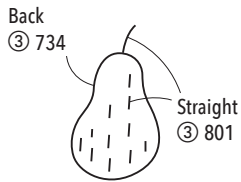

111

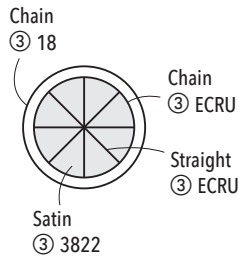

112

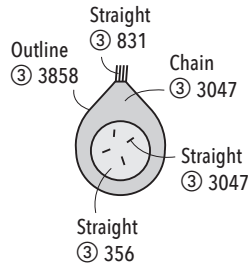

113

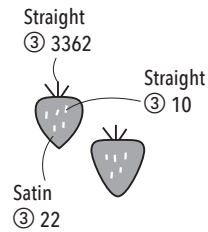

114

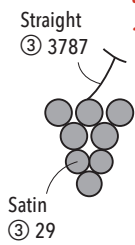

115

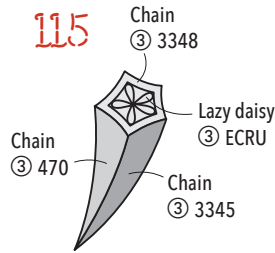

116

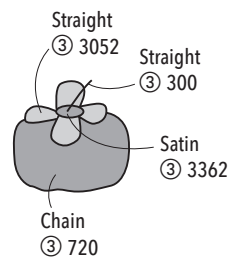

117

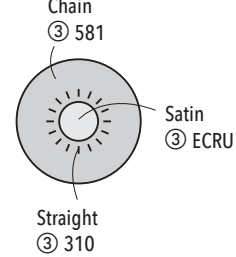

118

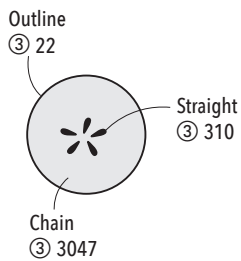

119



120

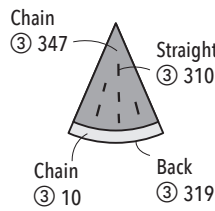

121

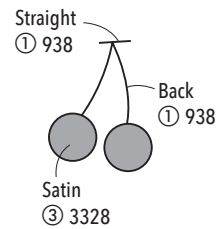

122



123

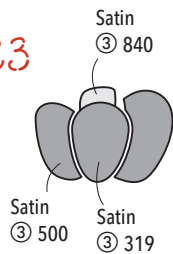

124

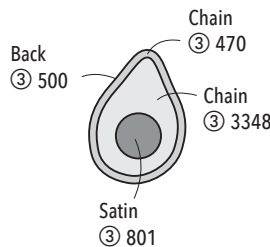

125

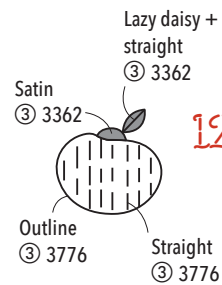

110

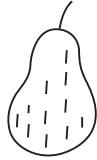

111

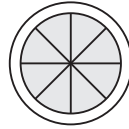

112



113

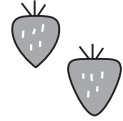

114

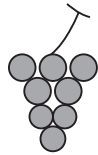

115



116



117

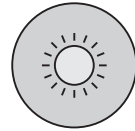

118



119



120



121

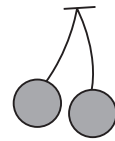

122



123

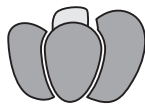

124



125



Favorite Foods

Photo: page 14

- The numbers represent the color numbers for Olympus No. 25 embroidery floss
- The numbers in ○ represent the number of strands of thread
- Wrap French knots twice, unless otherwise noted

126 French knot (3) 127 (wrap once)
 Straight (3) 127
 Satin (3) 700
 Straight (3) 734
 Straight (3) 800
 Satin (3) 712
 Satin (3) 190
 Satin (3) 228
 Satin (3) 778
 Satin (3) 532

127 Satin (3) 700
 Satin (3) 712
 Satin (3) 532

128 Satin (3) 190
 Satin (3) 712
 Satin (3) 900
 Satin (3) 190
 Satin (3) 551
 Lazy daisy (3) 276
 Stitch on top of satin (3) 551

129 French knot (3) 800
 Satin (3) 700
 Satin (3) 800

130 Satin (3) 733
 Satin (3) 532
 Satin (3) 190

131 Satin (3) 119
 Satin (3) 734
 Satin (3) 228
 Satin (3) 190
 Satin (3) 734
 Satin (3) 850

132 Satin (3) 735
 Satin + French knot (3) 785 (wrap once)

133 Satin (3) 712
 Satin (3) 190
 Satin (3) 850

134 Satin (3) 119
 Satin (3) 170
 Satin (3) 734

135 Satin (3) 546
 Satin (3) 700
 Straight (3) 700
 Straight (3) 546
 Satin (3) 546
 Satin (3) 700

136 Outline (3) 800
 Satin (3) 800
 Satin (3) 700
 Satin (3) 739
 Satin (3) 800

137 Straight (3) 484
 Satin (3) 785
 Satin (3) 231
 Straight (3) 484
 Satin (3) 785
 Satin (3) 551
 Satin (3) 532
 Straight (3) 484
 Outline (3) 484

138 Straight (3) 734
 Straight (3) 540
 Satin (3) 778
 Satin (3) 735
 Straight (3) 231
 Satin (3) 734

139 Outline (3) 1041 } Alternate colors
 Satin (3) 1041 }
 Satin (3) 900
 Straight (3) 733
 Satin (3) 712
 Back (3) 145
 Back (3) 119
 Satin (3) 800
 Satin (3) 521
 Satin (3) 735
 Outline (3) 800

140 Satin (3) 734

141 Satin (3) 712
 Satin (3) 778
 Satin (3) 484
 Straight (3) 540
 Satin (3) 734
 Straight (3) 231
 Straight (3) 735

126

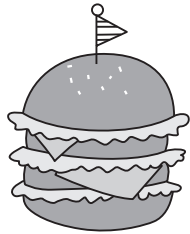

127



128



129



130

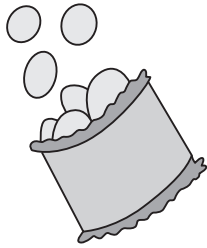

131

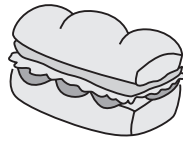

132

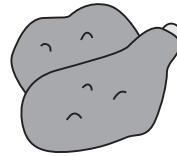

133



134

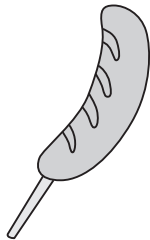

135



136



137

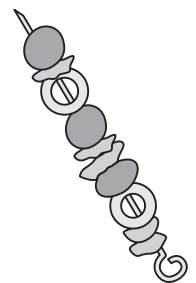

138

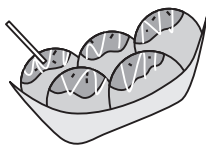

139



140

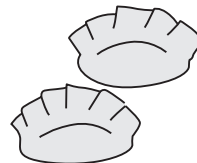

141



Sweets & Treats

Photo: page 15

- The numbers represent the color numbers for Olympus No. 25 embroidery floss
- The numbers in ○ represent the number of strands of thread
- Wrap French knots twice, unless otherwise noted

142 Satin (3) 192, Satin (3) 210, Satin (3) 800, Satin (3) 521, French knot (3) 192 (wrap once)

143 Outline (3) 731, Alternate colors (3) 800, Satin (3) 712, Straight (3) 712, Satin (3) 712

144 French knot (3) 521, (3) 1041, (3) 219 (wrap once), Satin (3) 778, Satin (3) 734, Straight (3) 731

145 Satin (3) 521, Satin (3) 800, Straight (3) 735, Satin (3) 735, Satin (3) 551, Satin (3) 103, Back (3) 778

146 Satin (3) 800, Satin (3) 712, Satin (3) 735, Satin (3) 192, Satin (3) 778, Satin (3) 734, Back (3) 383, French knot (3) 778

147 Satin (3) 190, Satin (3) 700, Back (3) 700, Satin (3) 540, Satin (3) 190, Satin (3) 778, Satin (3) 800, Satin (3) 521, French knot (3) 800 (wrap once), Satin (3) 228, French knot (3) 358 (wrap once), Satin (3) 532, Satin (3) 483

148 Satin (3) 700, French knot (3) 800 (wrap once), Satin (3) 735, Satin (3) 778, Satin (3) 800

149 Satin (3) 735, Satin (3) 800

150 Back (3) 190, Satin (3) 1041, Satin (3) 190, Straight (3) 383, Satin (3) 778, Back (3) 735, Satin (3) 735

151 Satin (3) 712, Satin (3) 521, Satin (3) 800

152 Satin (3) 276, Satin (3) 190, Satin (3) 655, Satin (3) 778, Satin (3) 733

153 Satin (3) 190, Satin (3) 800, Satin (3) 735, Satin (3) 1041, Satin (3) 228, Satin (3) 778, Satin (3) 190, Satin (3) 733, Satin (3) 1041, Satin (3) 800, Satin (3) 190, Outline (3) 370, Satin (3) 735, Satin (3) 370A

154 French knot (3) 738, Satin (3) 811, Outline (3) 190, Satin (3) 503, Satin (3) 542, Satin (3) 738, Satin (3) 190, Satin (3) 739, Satin (3) 811, Satin (3) 778, Satin (3) 800, Satin (3) 228, Satin (3) 117

155 Satin (3) 503, Satin (3) 735, Satin (3) 551

156 Satin (3) 190, Satin (3) 228, Satin (3) 1041, Satin (3) 358, Satin (3) 800, Satin (3) 735

157 Satin (3) 800, Satin (3) 739, Satin (3) 190, Satin (3) 190, Satin (3) 735, Satin (3) 1041

Stitch one grid at a time, changing direction

142

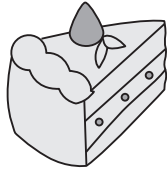

143



144

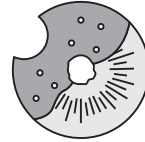

145



146

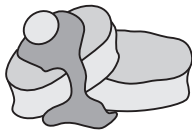

147



148



149



150



151

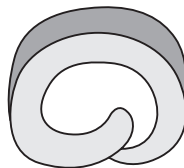

152



153



154



155



156



157



Zodiac Animals

Photo: page 16

- The numbers represent the color numbers for DMC No. 25 embroidery floss
- The numbers in ○ represent the number of strands of thread
- Wrap French knots twice, unless otherwise noted

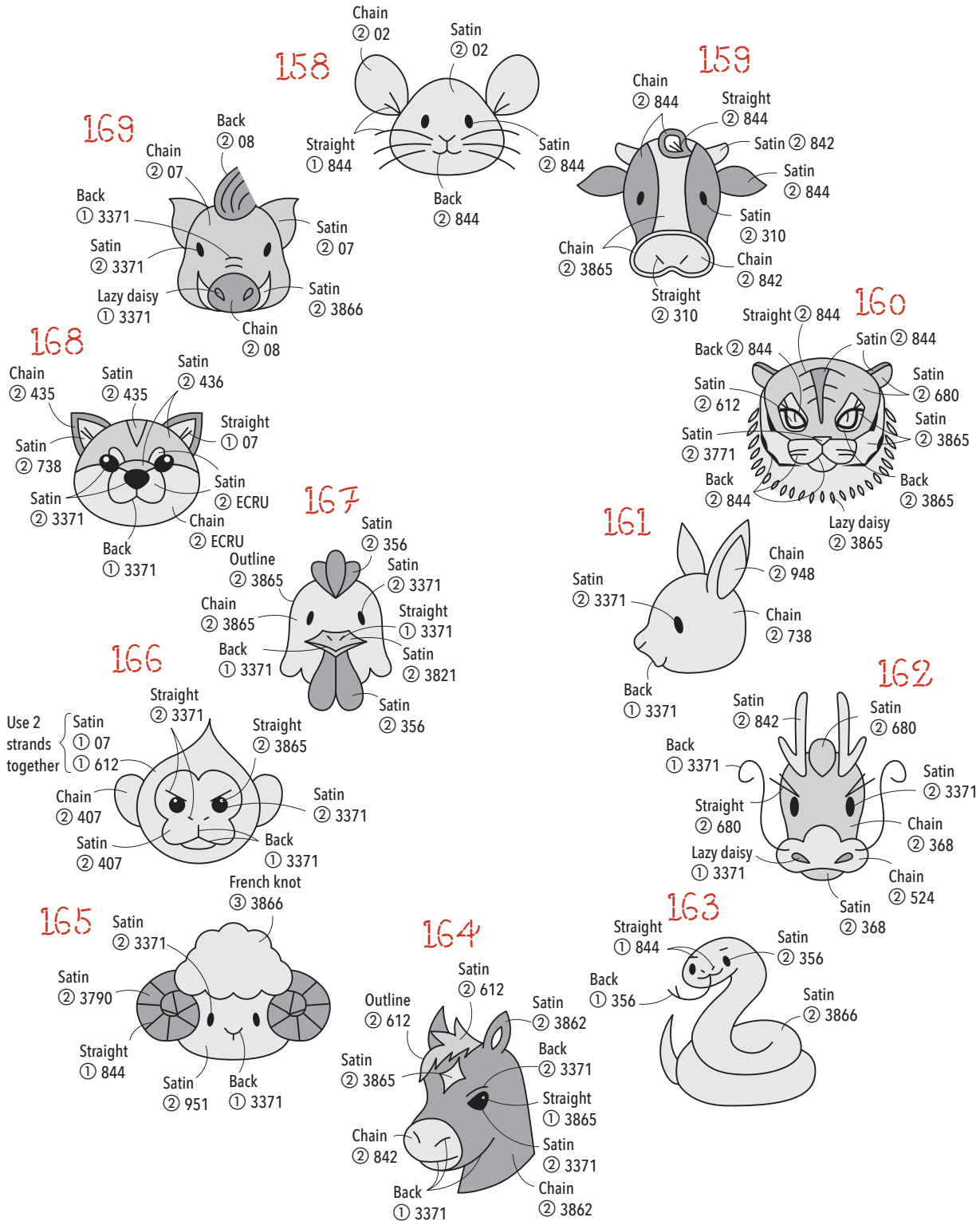

158

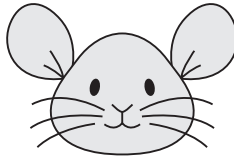

159

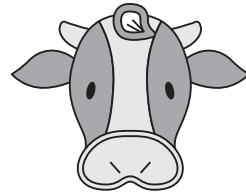

169



160



168



167



161



166

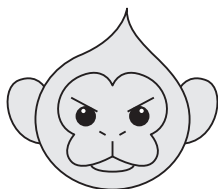

162

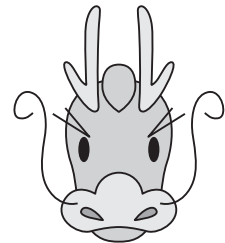

165



164



163



Dogs & Cats

Photo: page 17

- The numbers represent the color numbers for DMC No. 25 embroidery floss
- The numbers in ○ represent the number of strands of thread
- Wrap French knots twice, unless otherwise noted
- Satin ② 3371 for the eyes and straight ① BLANC for the eye highlights, unless otherwise noted

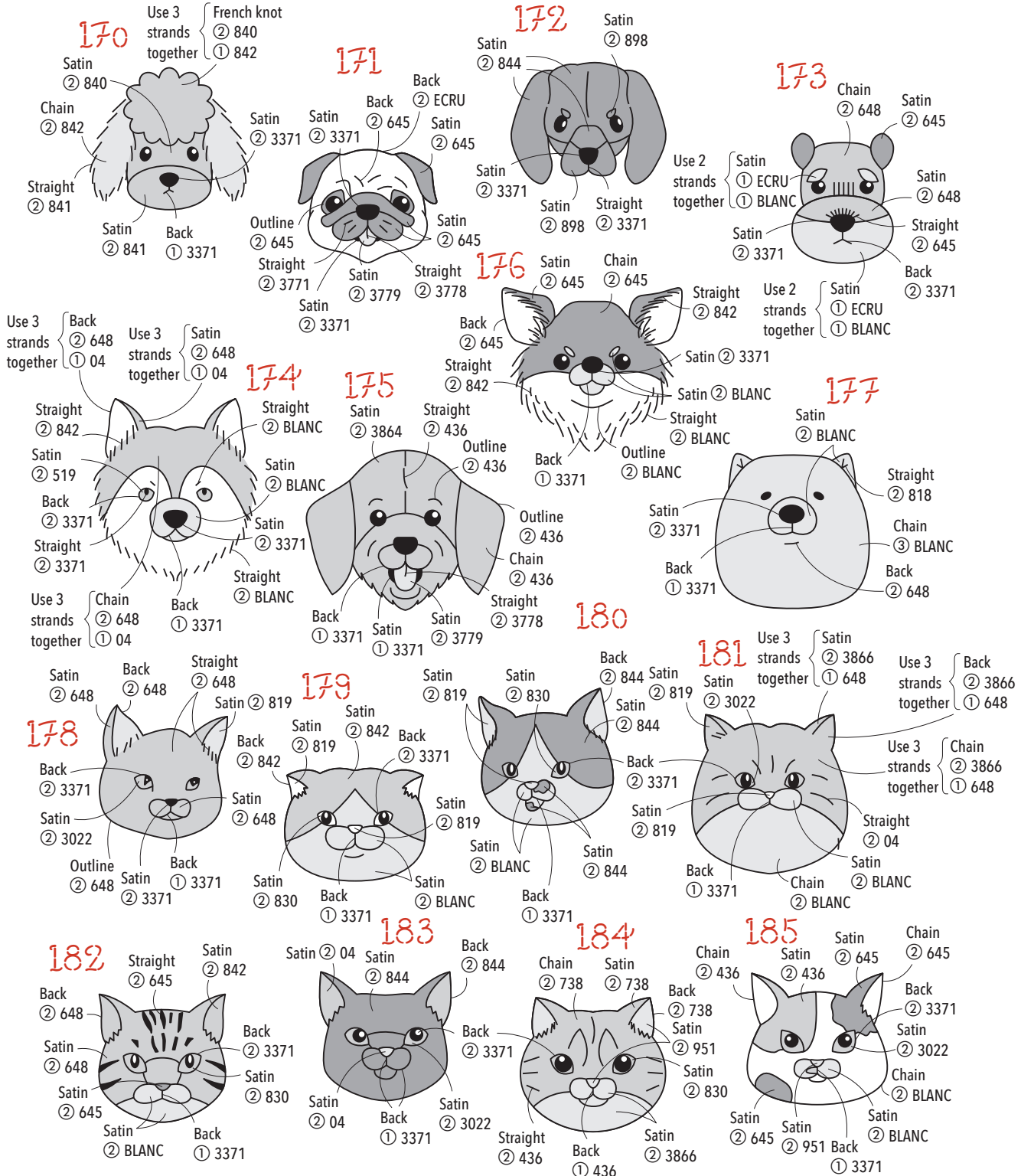

170



171



172

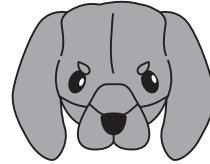

173

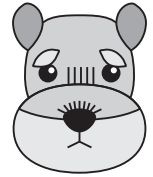

176

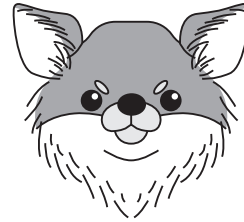

177

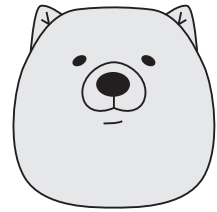

174



175

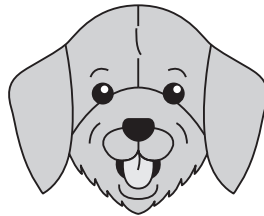

180



181

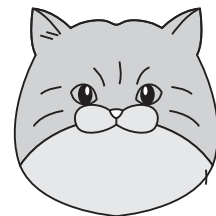

178



179



182



183



184

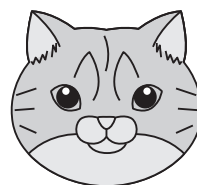

185



Favorite Animals

Photo: page 18

- The numbers represent the color numbers for DMC No. 25 embroidery floss
- The numbers in ○ represent the number of strands of thread
- Wrap French knots twice, unless otherwise noted

186 Bird: Satin ② 310, Outline ② 436, Straight ② 842, Straight ② 844, Satin ② 3862, Satin ② 844, Satin ② 645, Straight ② 842, Straight ② 436, Back ② 842, Back ② 407.

187 Bear: Back ② 839, Satin ② 842, Satin ② 839, Lazy daisy knot ② 839, Back ① 839.

188 Pig: Lazy daisy ② 819, Satin ② 818, Satin ② 819, Satin ① 844, Satin ① 844, Back ① 844, Satin ② 645, Outline ① 818, Satin ② 819.

189 Swallow: Satin ② 436, Satin ② 310, Satin ② 645, Outline ① 924, Outline ① 844, Chain ① 924, Chain ① 844. Use 2 strands together.

191 Stork: Satin ① 221, Chain ① 310, Straight ① 310, Straight ② 3371, Satin ② 3371, Straight ① 3865, Back ① 3371, Outline ① 310, Satin ② 3371, Satin ② 08, Satin ② 3866, Satin ② 03.

192 Turtle: Straight ① 3371, Back ② 3347, Lazy daisy ② 3347, Straight ① 3865, Satin ② 524, Satin ② 08, Straight ① 3865, Straight ② 08, Satin ② 03.

193 Fox: Straight ① 645, Satin ② 648, Satin ② 422, Chain ② 645, Satin ② 648, Lazy daisy ② 645, Straight ① 3371, Back ② 3371, Satin ② 3371, Straight ② 648, Straight ② 645, Straight ② 648. Alternate colors.

194 Cat: Satin ② 819, Back ② 407, Back ② 3371, Satin ② 819, Satin ② 3866, Straight ① 3371, Straight ② 645, Outline ② 645, Satin ② 3866.

196 Donkey: Straight ① 3371, Satin ② 04, Satin ② 08, Outline ② 03, Lazy daisy ② 08.

197 Crab: Chain ② 356, Straight ② 844, Satin ② ECRU, Back ② 356, Back ② ECRU, Chain ② 356, Satin ② 3865, Back ① 844, Satin ② 844, Back ② ECRU, Straight ② 356.

198 Raccoon: Satin ② 3790, Chain ② 844, Chain ② 3790, Chain ② 841, Chain ② 841, Lazy daisy ② 841, Straight ① 3865, Satin ② 3371, Back ① 3371, Lazy daisy ② 844, Chain ② 841, Chain ② 3790. Use 2 strands together.

199 Duck: Satin ② 310, Chain ② 02, French knot ② 02, Satin ② 04, Lazy daisy ② 02, Satin ② 04.

200 Frog: Satin ② 844, Satin ② 3347, Satin ① 3365, Chain ① ECRU, Satin ② 3013, Chain ② 3347, Straight ② 3013, Lazy daisy ② 3347, French knot ② 3013, French knot ② 3347.

201 Turtle: Satin ② 3371, Satin ② 502, Straight ① 3371, Outline ② 3865, Chain ② 08, Straight ② 842, Lazy daisy ② 08, Chain ② 842, Lazy daisy ② 722, Straight ② 722, Satin ② 3821.

186



187



188



189

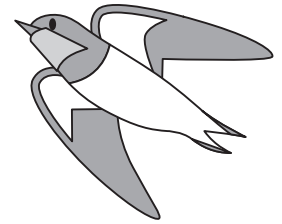

191

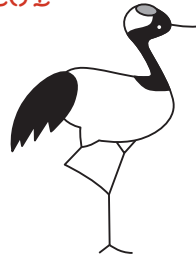

192

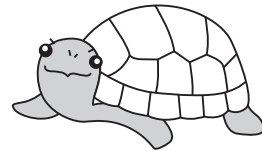

190



193



196

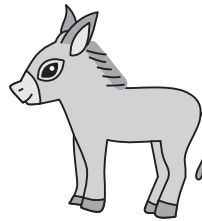

194

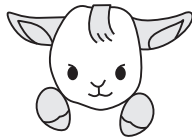

195



197

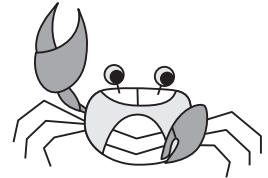

198



199

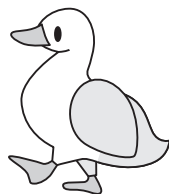

200



201

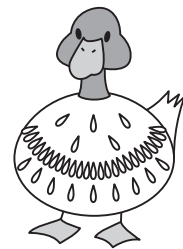

Favorite Animals

Photo: page 19

- The numbers represent the color numbers for DMC No. 25 embroidery floss
- The numbers in ○ represent the number of strands of thread
- Wrap French knots twice, unless otherwise noted
- Satin ② 3371 for the eyes, unless otherwise noted
- Straight ① BLANC for the eye highlights, unless otherwise noted

202

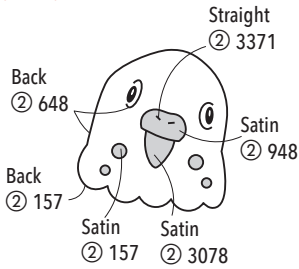

203

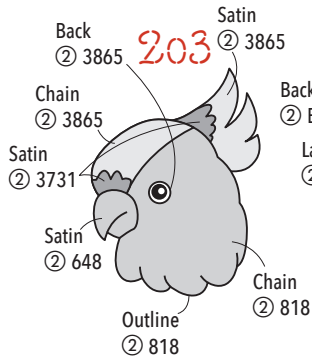

204

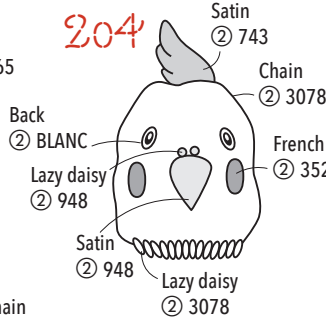

205



206

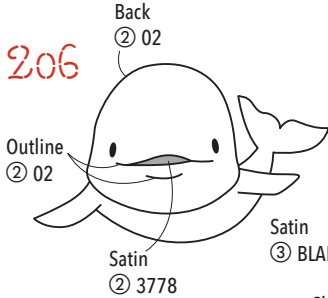

207

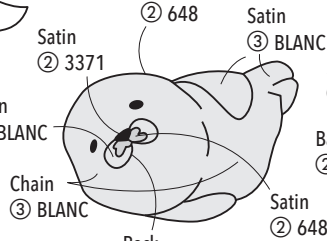

208

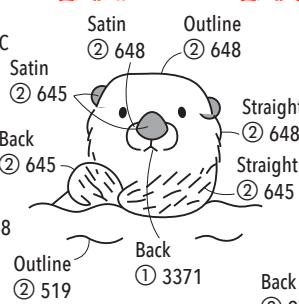

209

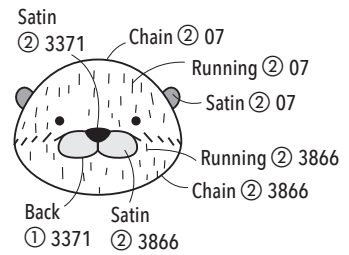

210

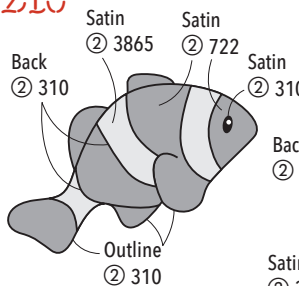

211

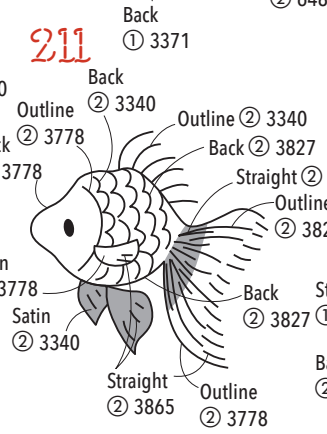

212



213

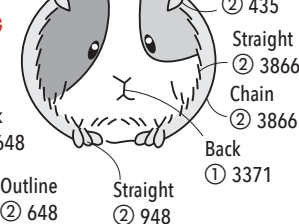

214

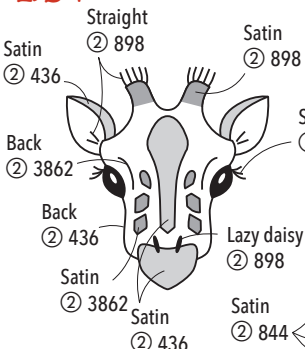

215

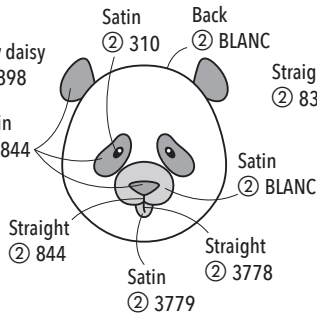

216

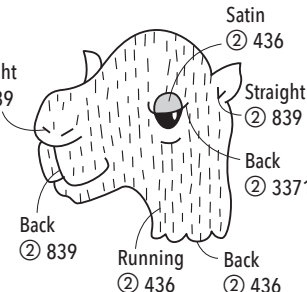

217



202



203



204



205

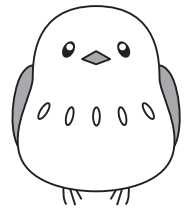

206

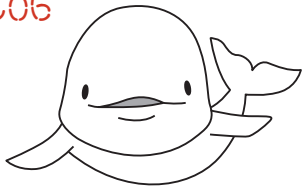

207

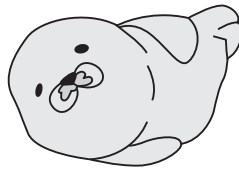

208



209



210

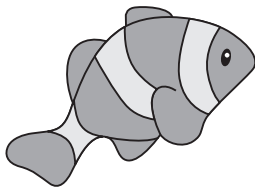

211

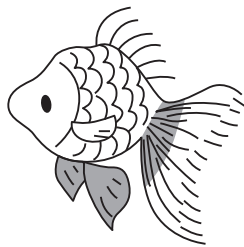

212

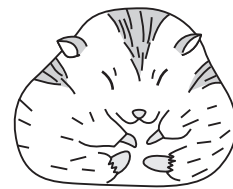

213

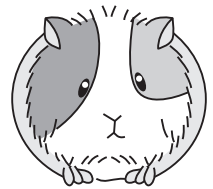

214



215



216

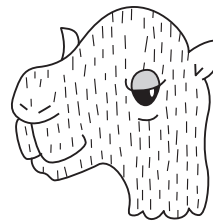

217



Animal Friends

Photo: page 20

- The numbers represent the color numbers for DMC No. 25 embroidery floss
- The numbers in ○ represent the number of strands of thread
- Wrap French knots twice, unless otherwise noted
- Straight ① 310 for the eyes, nose, and mouth, unless otherwise noted

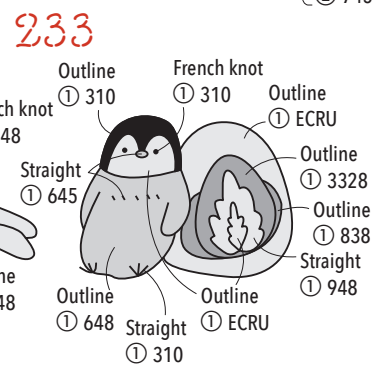
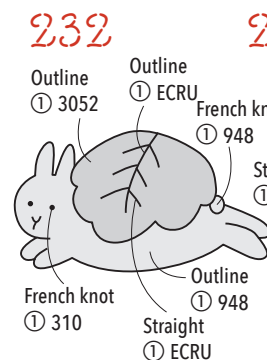
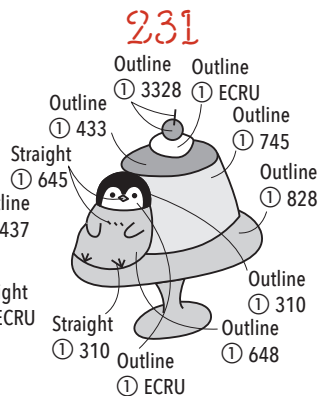
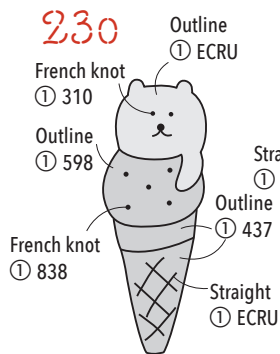
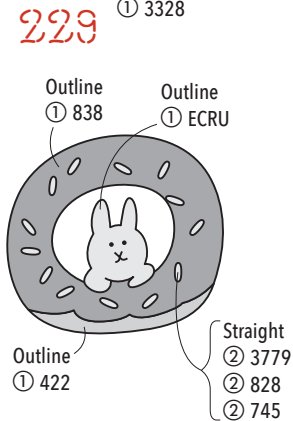
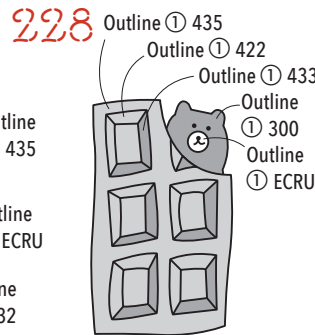
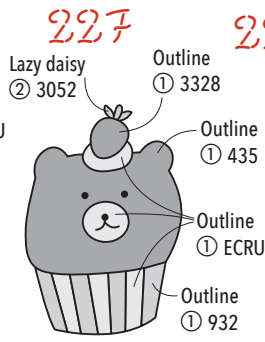
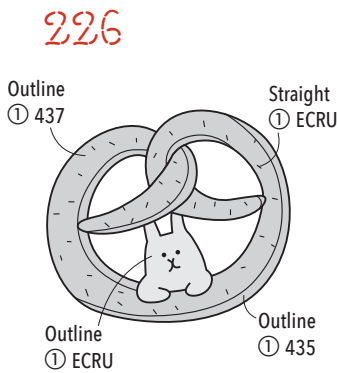
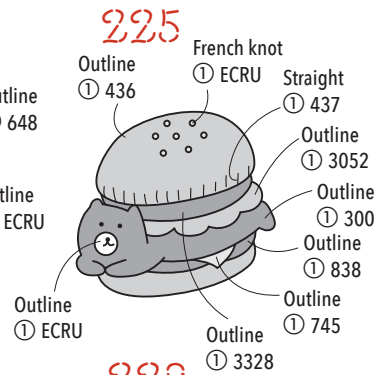
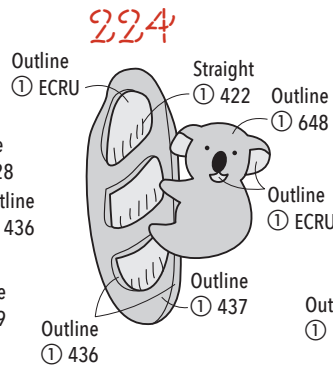
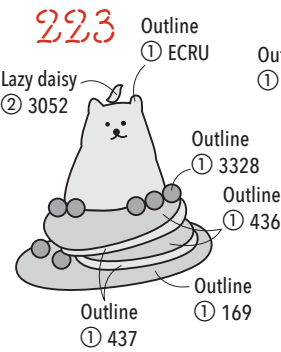
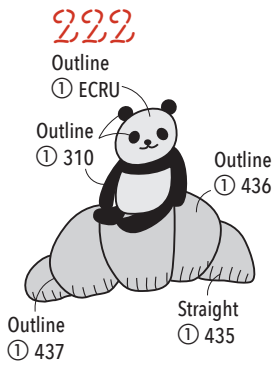
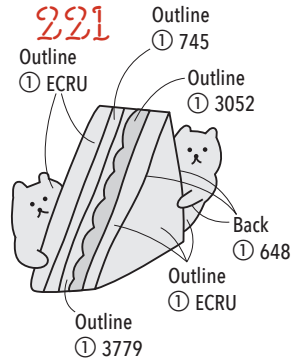
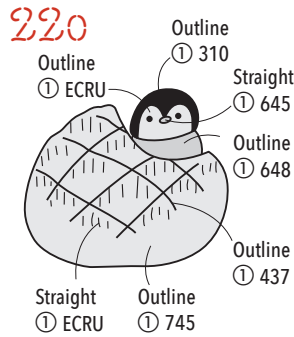
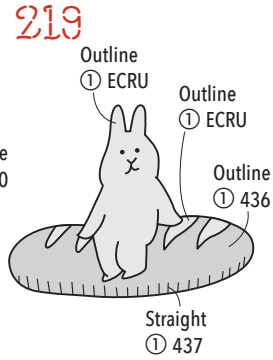
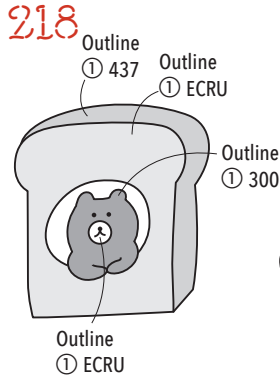

218



219

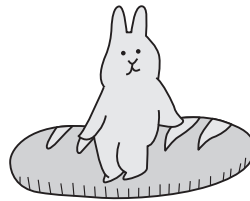

220

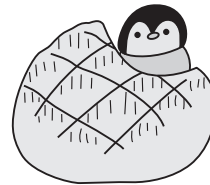

221

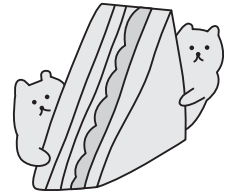

222

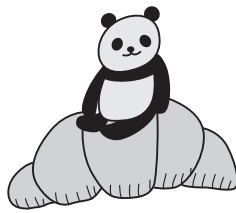

223



224

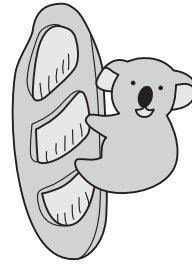

225

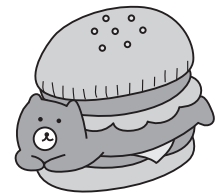

226

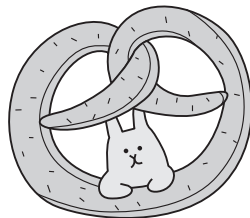

227



228

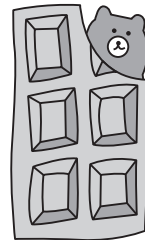

229

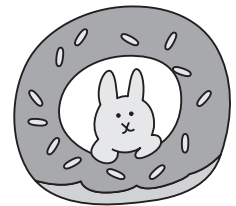

230



231

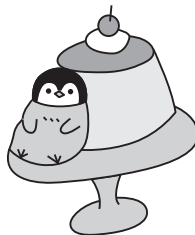

232



233

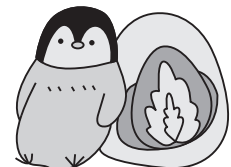

Animal Friends

Photo: page 21

- The numbers represent the color numbers for DMC No. 25 embroidery floss
- The numbers in ○ represent the number of strands of thread
- Wrap French knots twice, unless otherwise noted
- Straight ① 310 for the eyes, noses, and mouth, unless otherwise noted

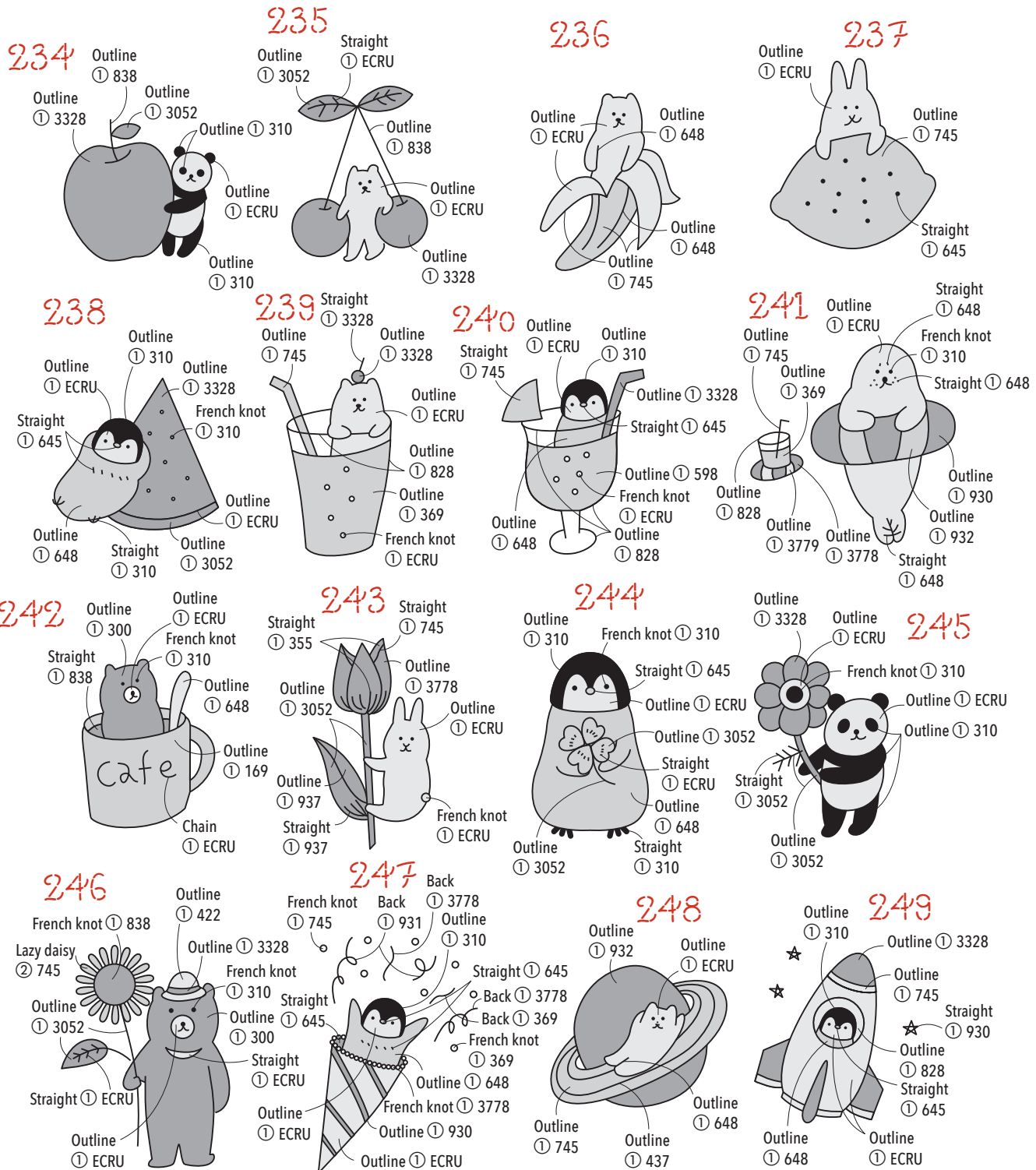

234



235

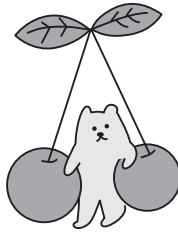

236

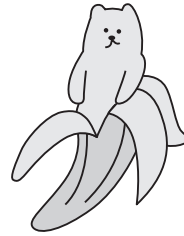

237

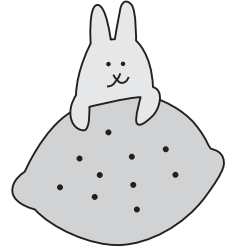

238

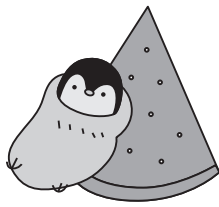

239



240



241

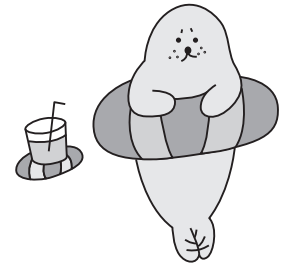

242



243

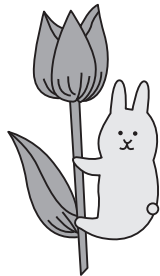

244



245



246

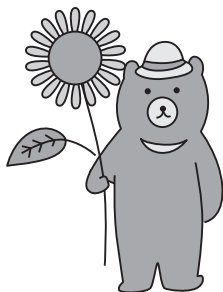

247

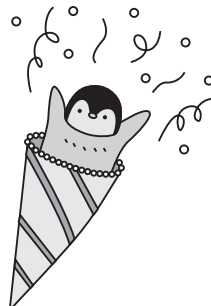

248

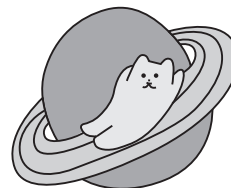

249

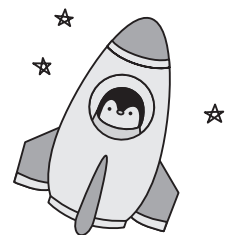

Fairy Tale Animals

Photo: page 22

- The numbers represent the color numbers for DMC No. 25 embroidery floss
- The numbers in ○ represent the number of strands of thread
- Wrap French knots twice, unless otherwise noted
- Straight ① 3781 for the eyes and whiskers, unless otherwise noted
- French knot ① 3781 for the noses, unless otherwise noted

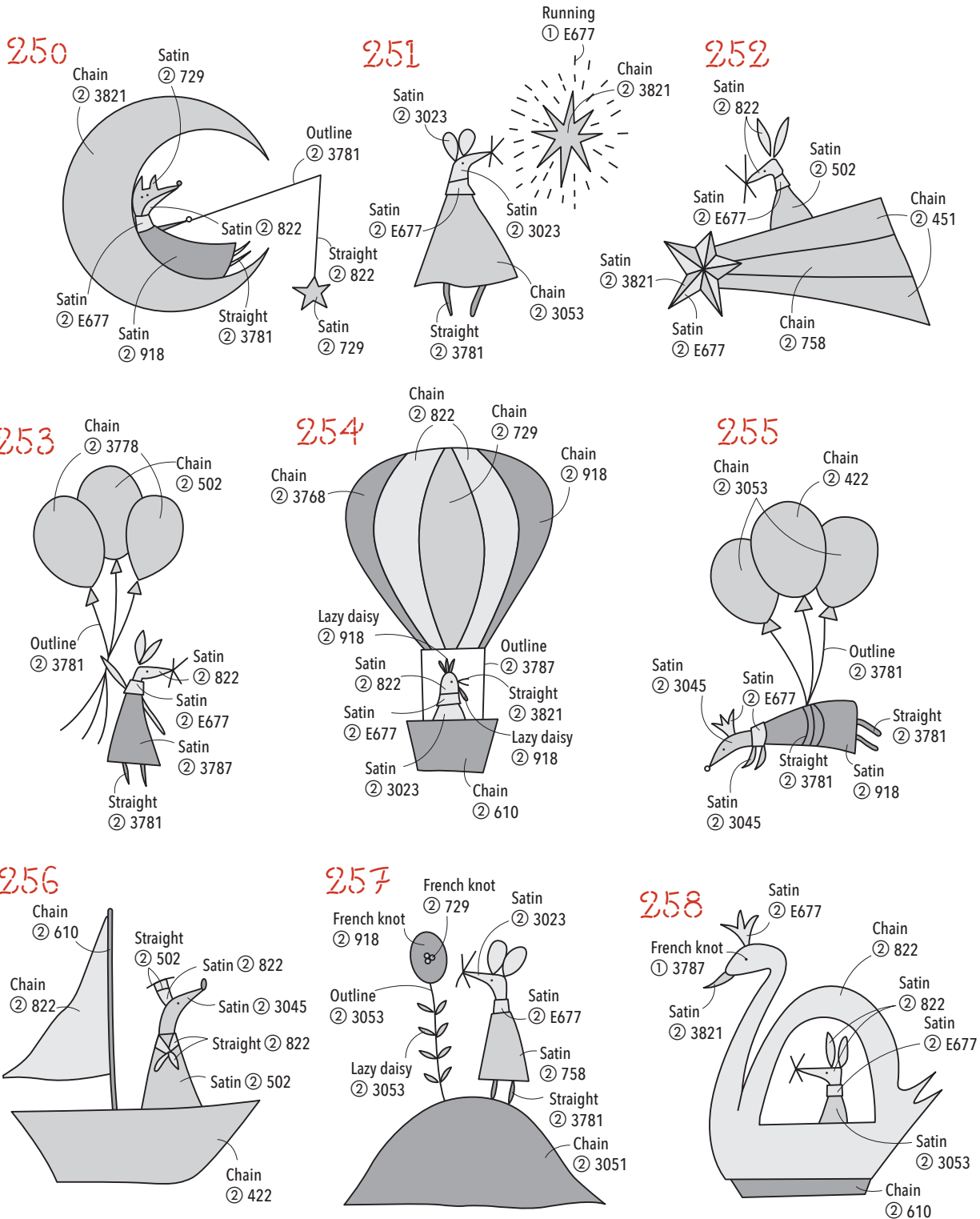

250

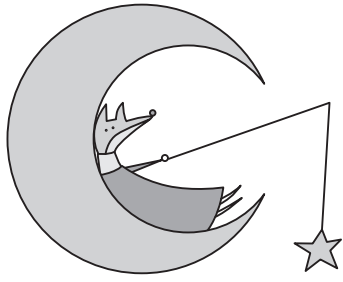

251



252

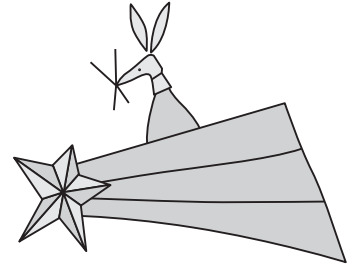

253

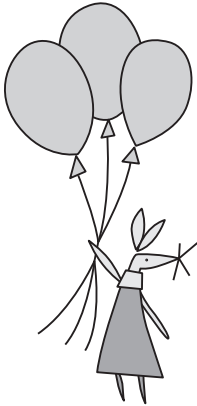

254

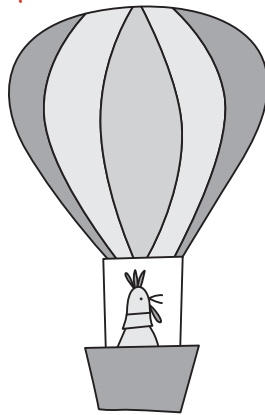

255

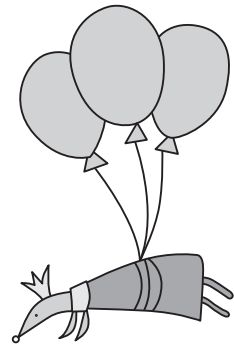

256

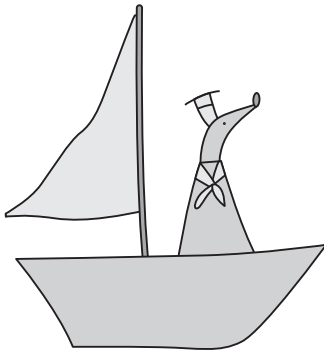

257

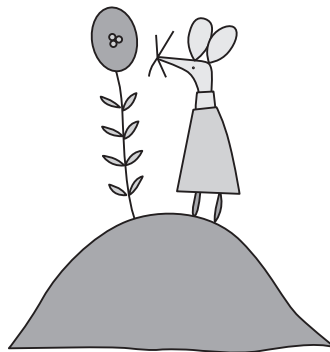

258

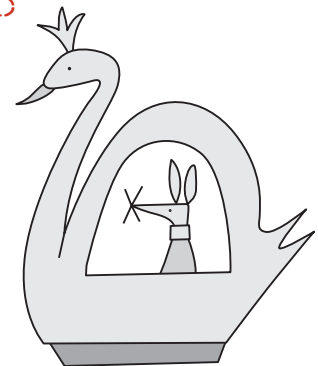

Fairytale Animals

Photo: page 23

- The numbers represent the color numbers for DMC No. 25 embroidery floss
- The numbers in ○ represent the number of strands of thread
- Wrap French knots twice, unless otherwise noted
- Straight ① 3781 for the eyes and whiskers, unless otherwise noted
- French knot ① 3781 for the noses, unless otherwise noted

259

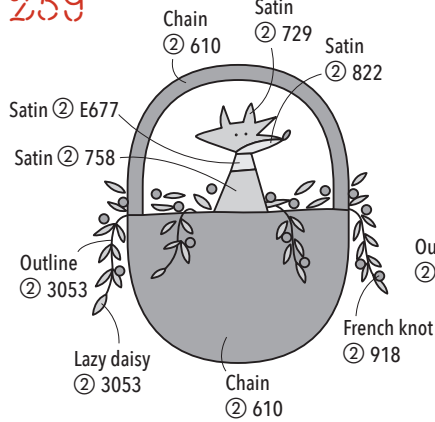

260

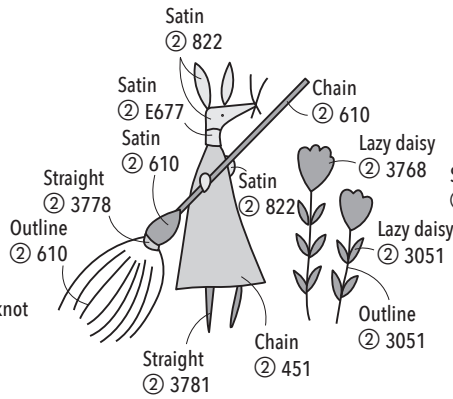

261

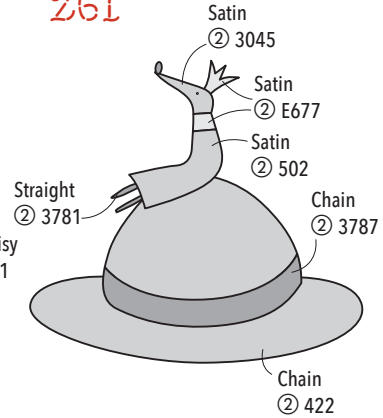

262

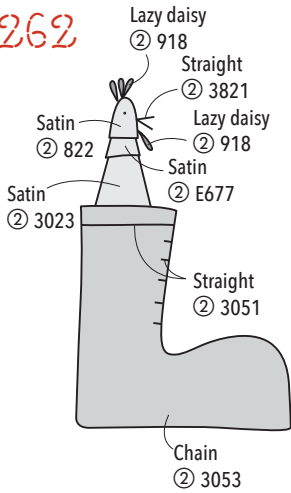

263

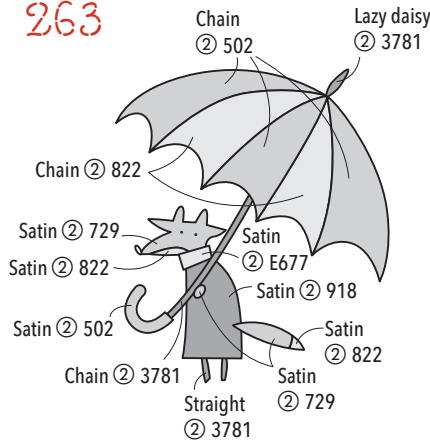

264

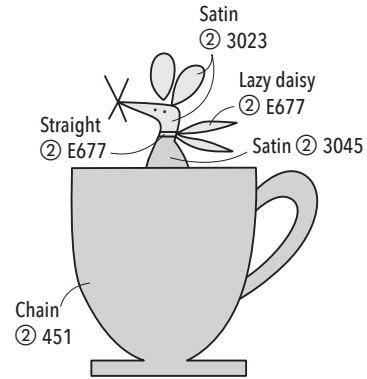

265

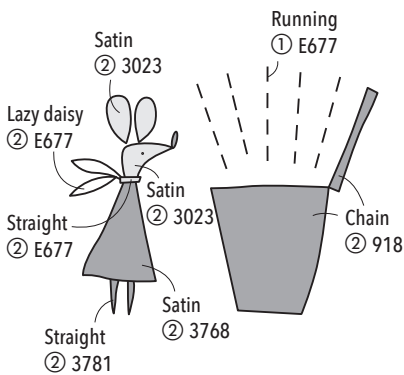

266

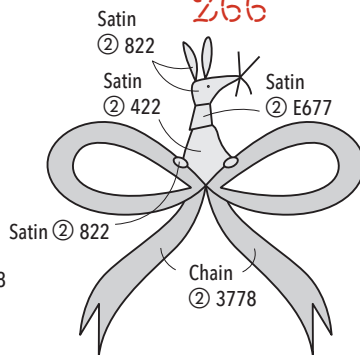

267

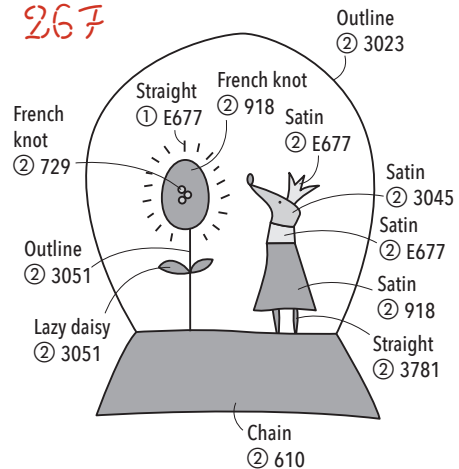

259

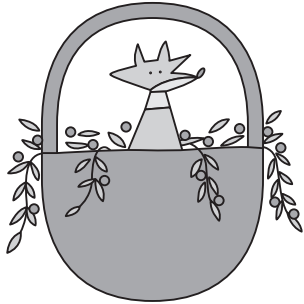

260



261

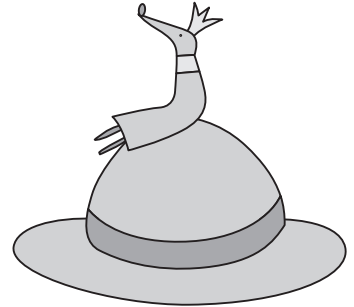

262

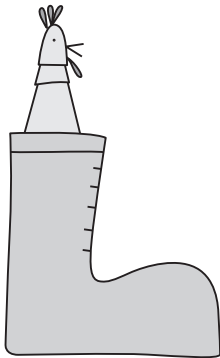

263



264

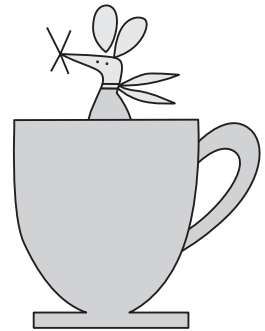

265

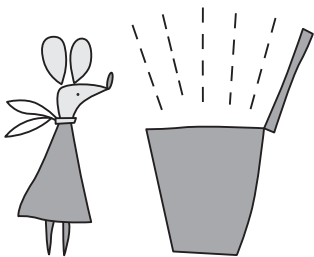

266

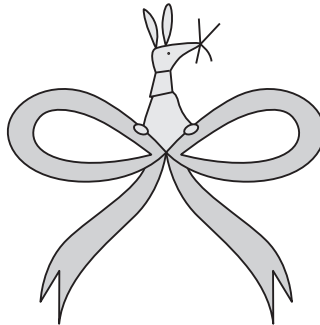

267

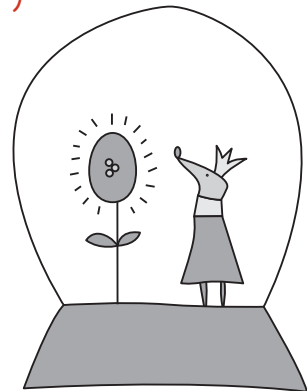

More Fairytale Animals

Photo: page 24

- The numbers represent the color numbers for DMC No. 25 embroidery floss
- The numbers in ○ represent the number of strands of thread
- Wrap French knots twice, unless otherwise noted
- Straight ① 3781 for the eyes and whiskers, unless otherwise noted
- French knot ① 3781 for the noses, unless otherwise noted

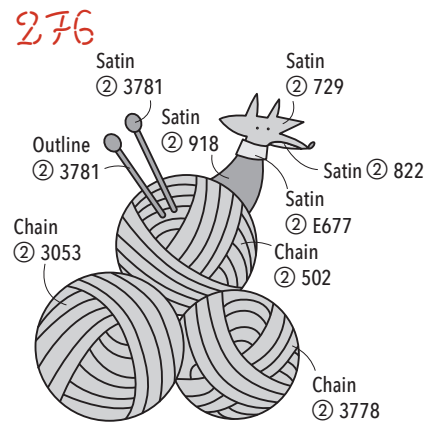
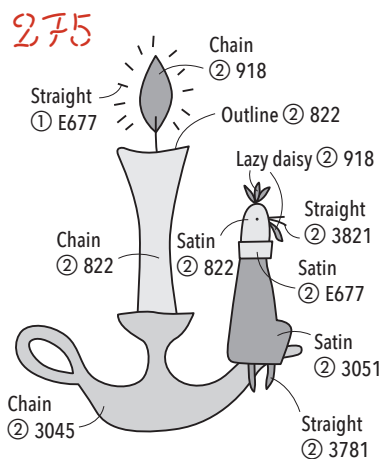
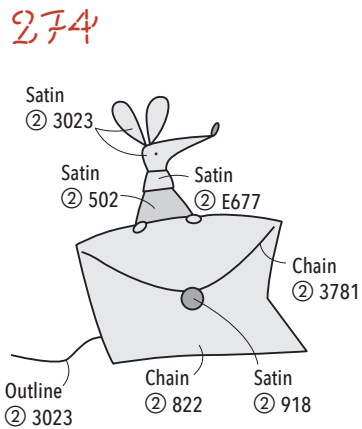
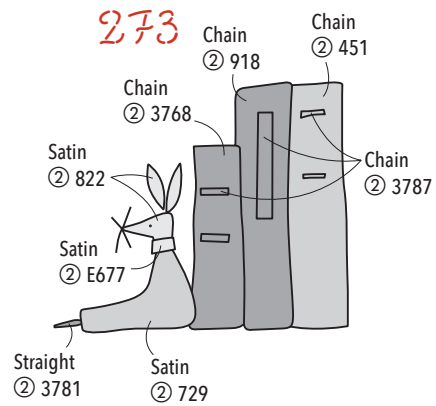
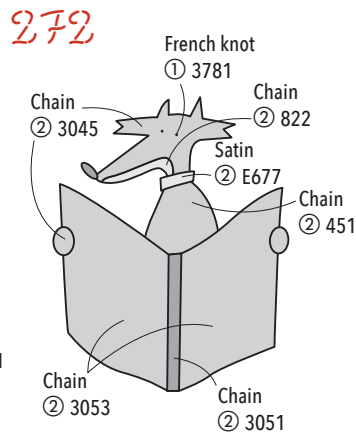
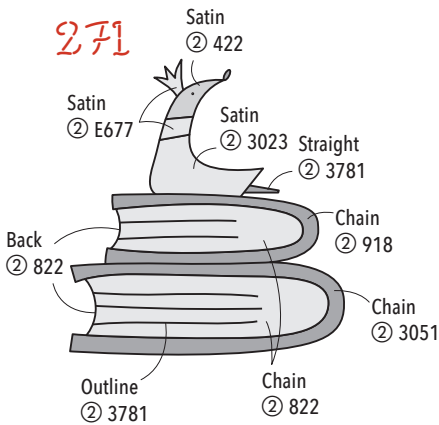
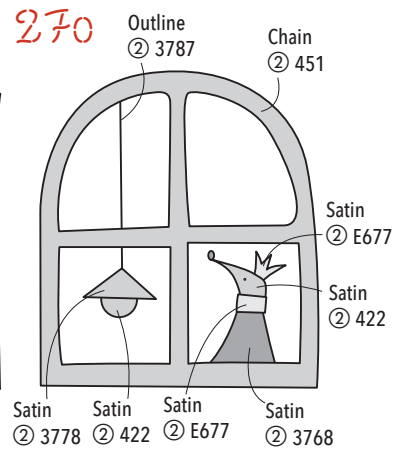
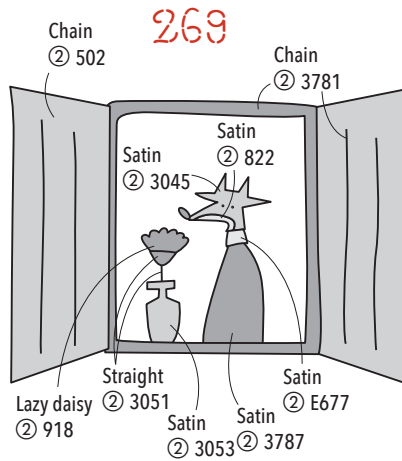
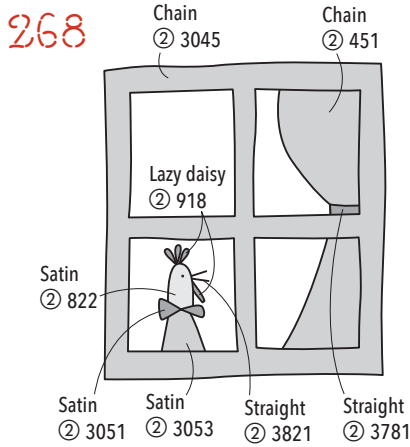

268

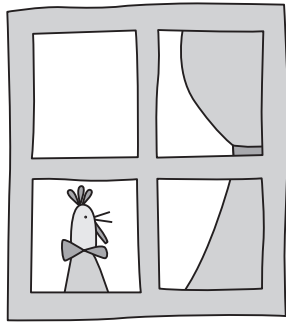

269

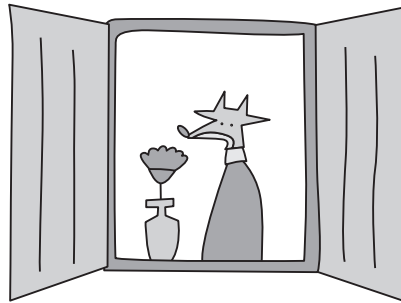

270

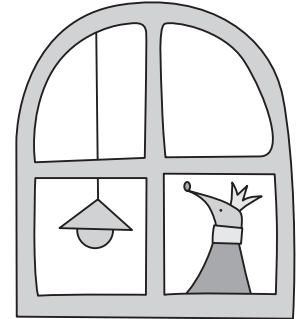

271



272

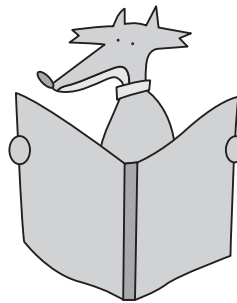

273



274

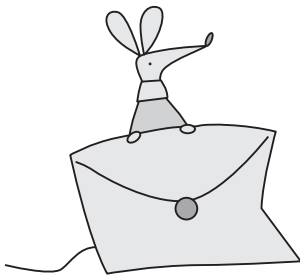

275

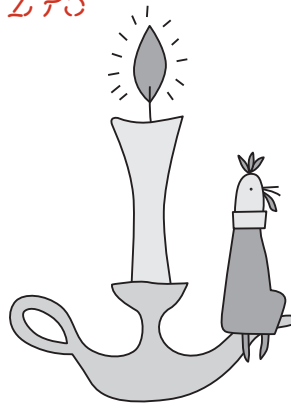

276

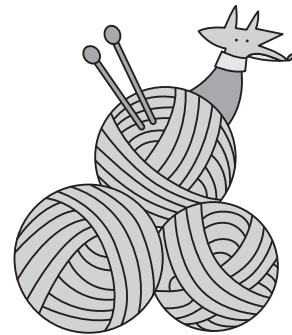

More Fairytale Animals

Photo: page 25

- The numbers represent the color numbers for DMC No. 25 embroidery floss
- The numbers in ○ represent the number of strands of thread
- Wrap French knots twice, unless otherwise noted
- Straight ① 3781 for the eyes and whiskers, unless otherwise noted
- French knot ① 3781 for the noses, unless otherwise noted

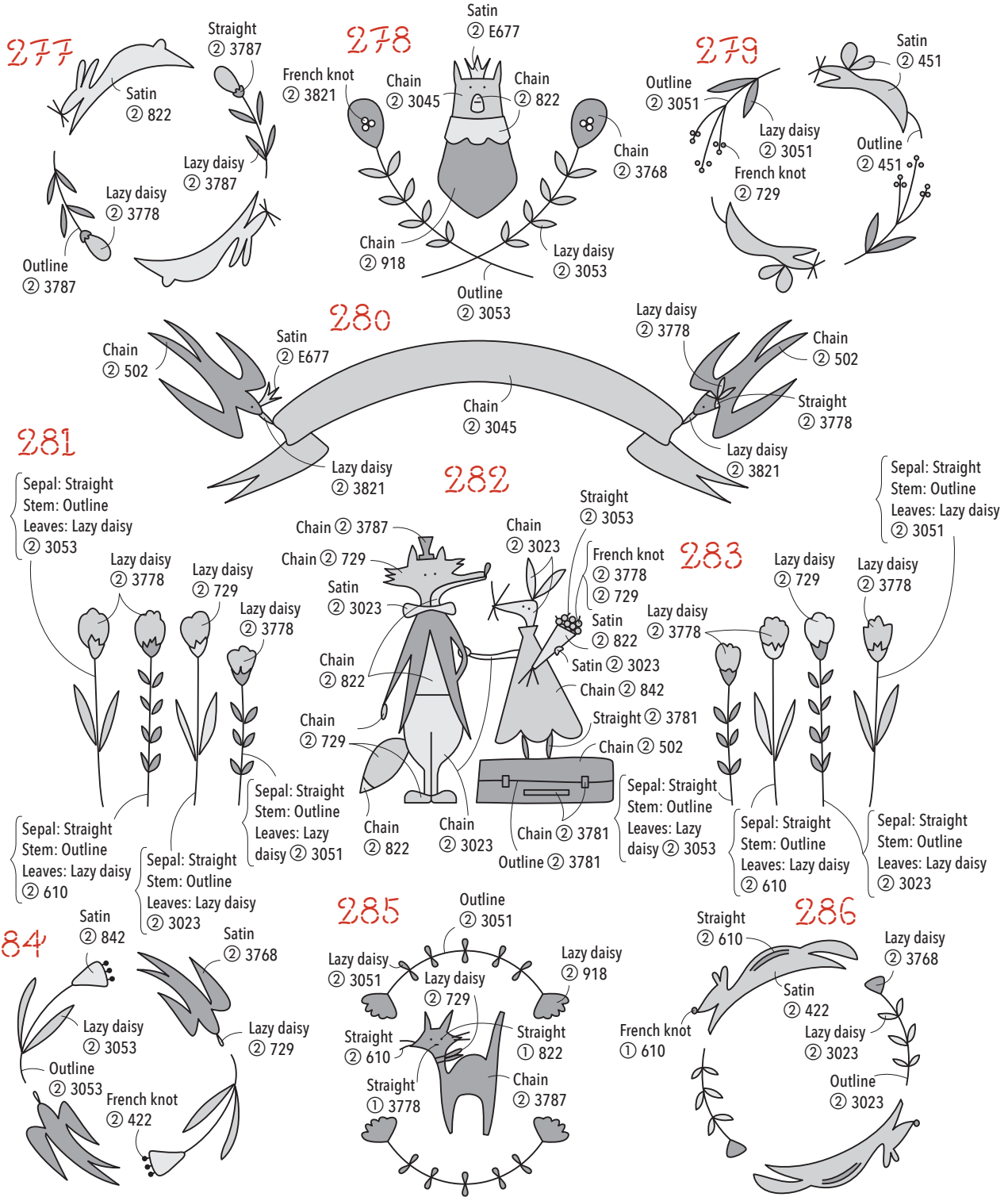

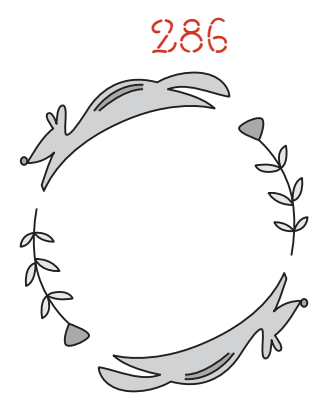
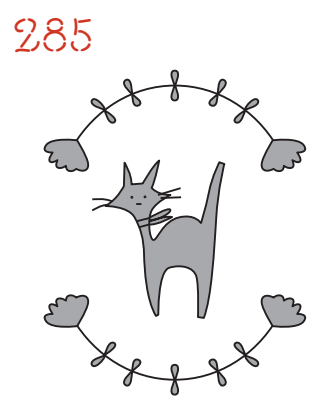
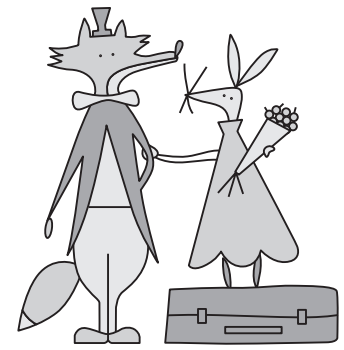
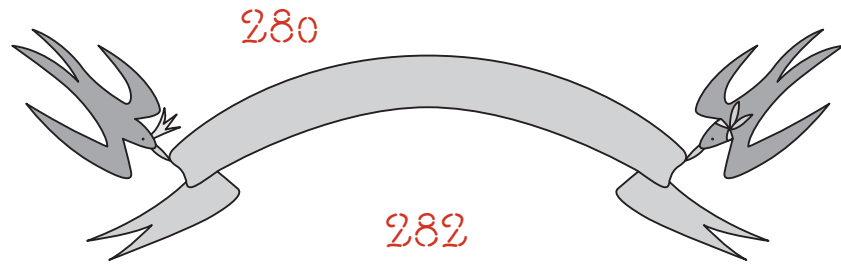
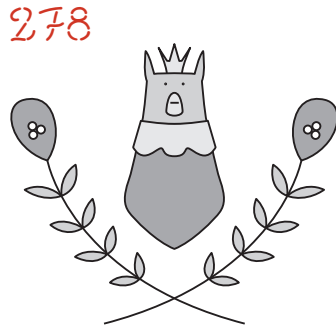

Everyday Life

Photo: page 26

- The numbers represent the color numbers for DMC No. 25 embroidery floss
- The numbers in ○ represent the number of strands of thread
- Wrap French knots twice, unless otherwise noted

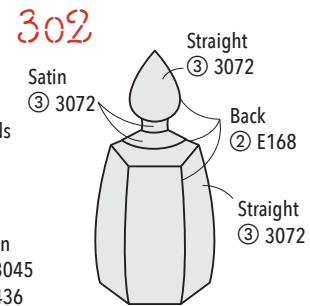
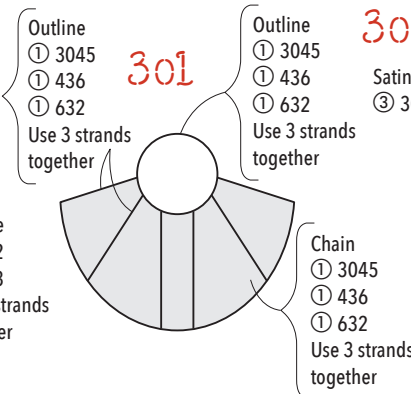
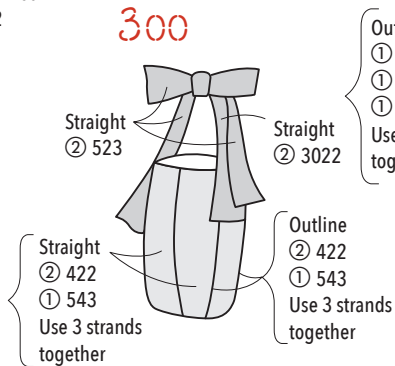
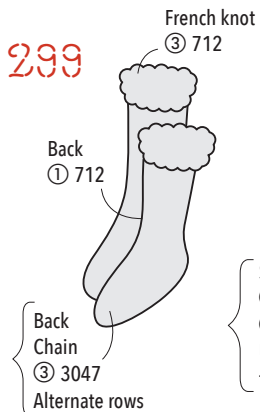
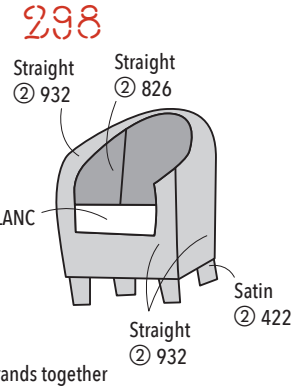
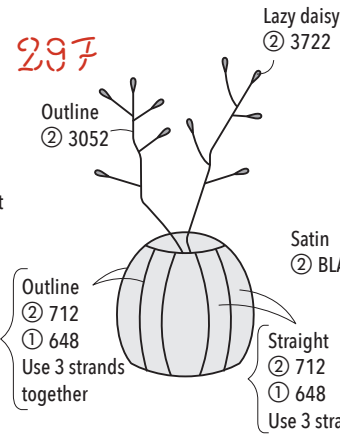
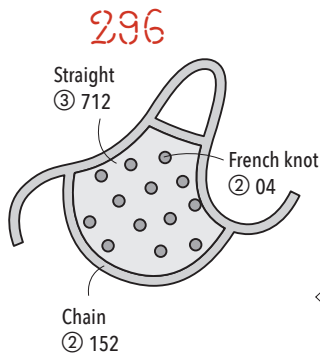
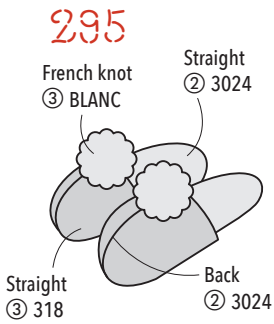
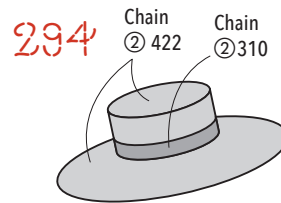
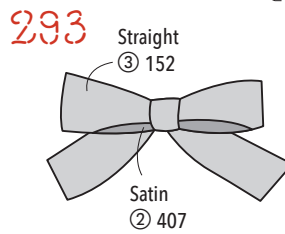
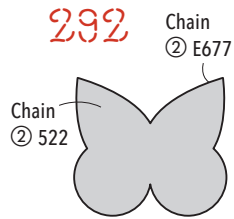
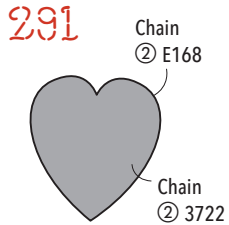
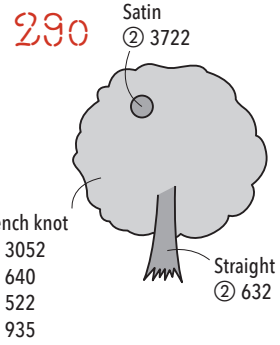
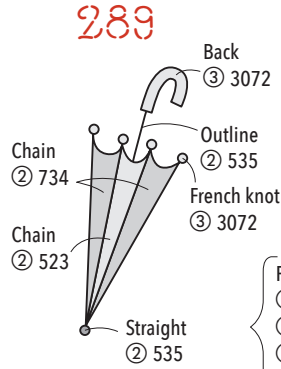
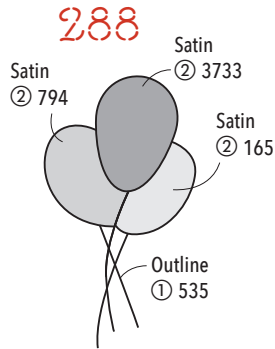
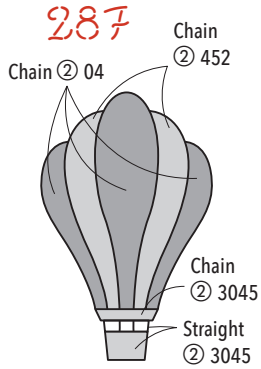

287

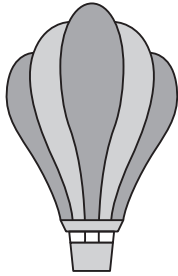

288

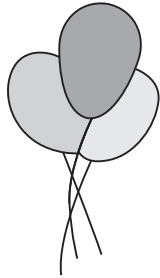

289

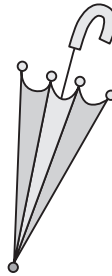

290

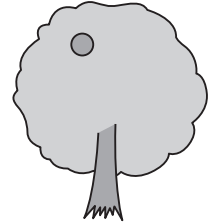

291



292

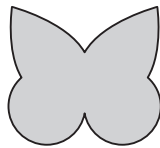

293

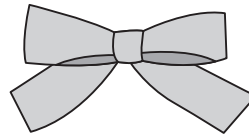

294

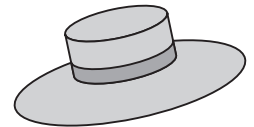

295

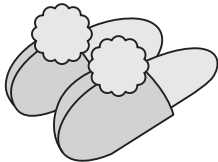

296

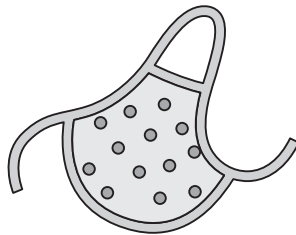

297



298

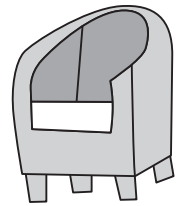

299



300

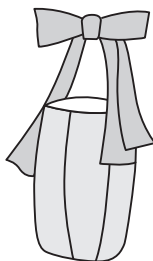

301

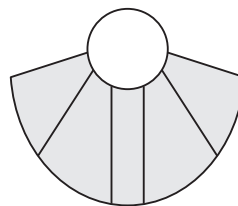

302



Everyday Life

Photo: page 27

- The numbers represent the color numbers for DMC No. 25 embroidery floss
- The numbers in ○ represent the number of strands of thread
- Wrap French knots twice, unless otherwise noted

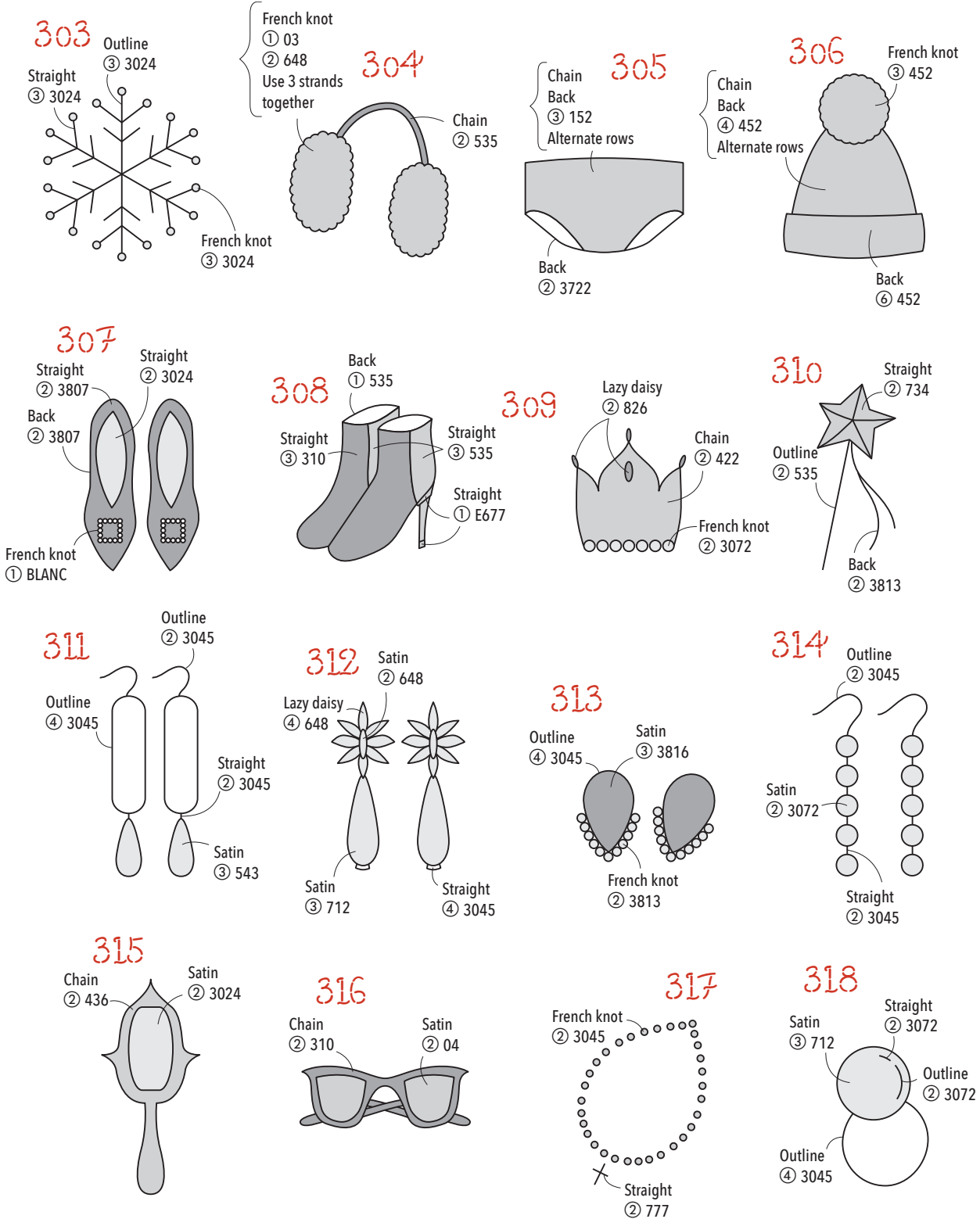

303

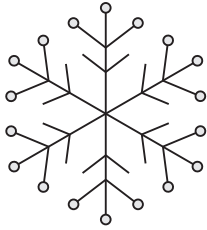

304

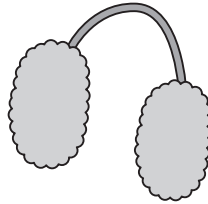

305

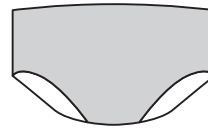

306

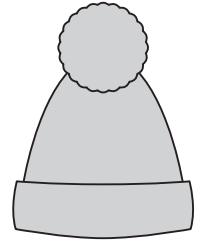

307

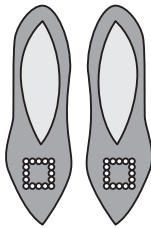

308



309

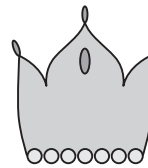

310

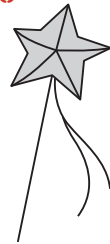

311

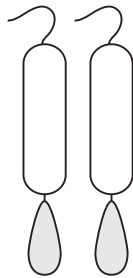

312

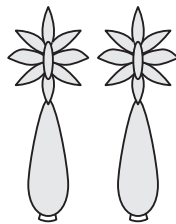

313

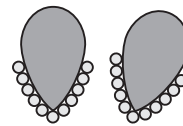

314

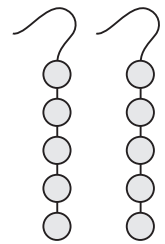

315



316



317

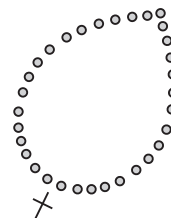

318

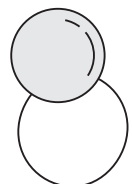

Sports & Games

Photo: page 28

- The numbers represent the color numbers for DMC No. 25 embroidery floss
- The numbers in ○ represent the number of strands of thread
- Wrap French knots twice, unless otherwise noted

319 Baseball bat: Straight ① 356, Back ① 844, Outline ② 3866, Satin ② 422

320 'We love base ball!': Straight ② 3363, Back ② 3363, Satin ② 3363, Lazy daisy ② 680, French knot ② 680, Back ① 356

321 Baseball cap: Straight ① 3865, Back ② 3865, French knot ② 939, Satin ② 939

322 Baseball glove: Straight ① 08, Back ① 3862, Back ② 3862, Running ① 08

323 Trophy: Satin ② 3363, Satin ② 612, Chain ② 612, Straight ② 3866, Satin ② 612, Satin ② 08

324 Sneakers: Outline ② 844, Outline ② 3348, Back ① 844, Straight ② 844, Outline ② 3348

325 'Goal!': Chain ② 597, Straight ② 3768, Outline ② 3768, Outline ① 3768, Satin ② 3768

326 Soccer ball: Straight ② 310, Outline ② 310, Satin ② 310

327 'Attack!': Outline ② 3861, Satin ② 3861, French knot ② 3861

328 Tennis racket: Satin ① 3821, Back ① 844, Back ② 152, Back ② 3865, Chain ② 160, Straight ① 03

329 Tennis balls: Outline ① 3821, Outline ① 3842, Outline ① 368, Outline ① 356, Outline ① 3866, Outline ② 645

330 Volleyball jersey: Satin ② 422, Satin ② 356, Satin ② 422, Back ① 356, Back ② 356

331 Basketball: Chain ② 435, Back ② 844

332 Basketball jersey: Outline ② 310, Back ① 310, Back ② 3813, Satin ② 3813, Chain ② 3813

333 Basketball hoop: Chain ② 3771, Back ② 02

334 'One for All, All for One': Back ① 844, Back ② 152

We love
base
ball!

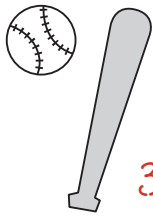

319



321

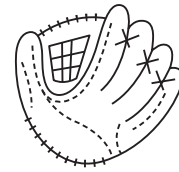

322

323



324



325



326



329

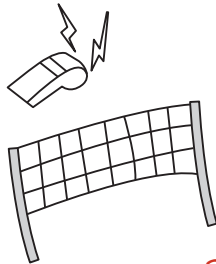

328

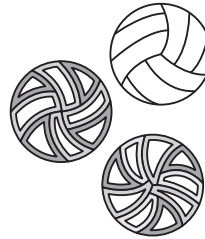

330

Attack!!

327

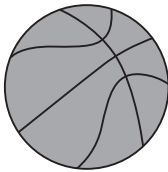

331



332

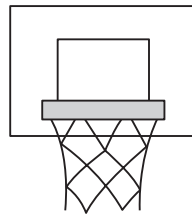

333

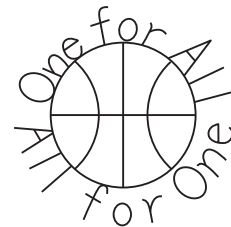

334

Sports & Games

Photo: page 29

- The numbers represent the color numbers for DMC No. 25 embroidery floss
- The numbers in ○ represent the number of strands of thread
- Wrap French knots twice, unless otherwise noted

335

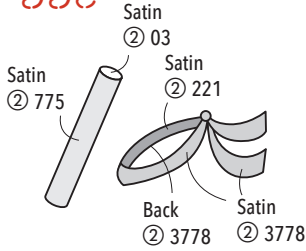

336

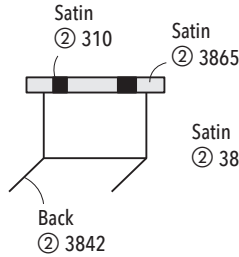

337

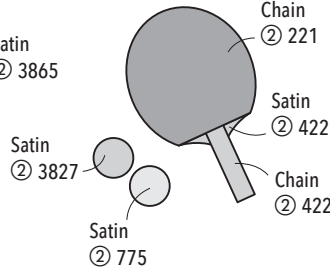

Back 1 645 French knot 1 645 338

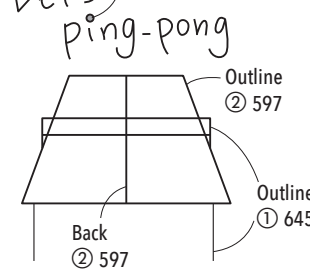

339

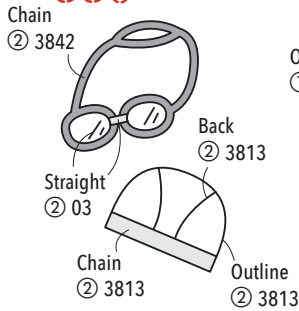

340

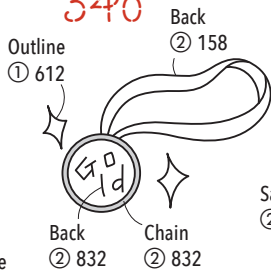

341

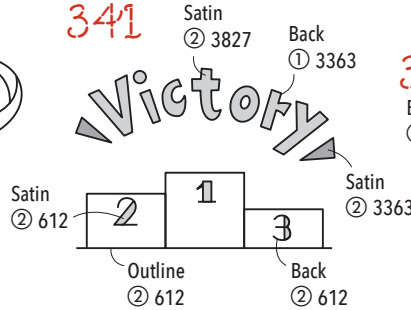

342

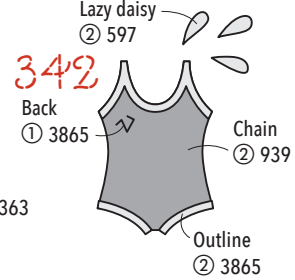

343

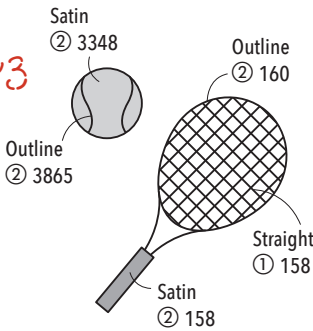

344

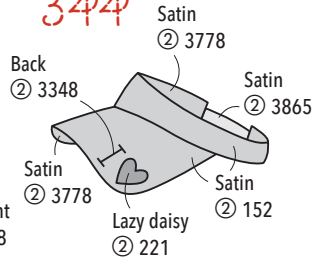

345

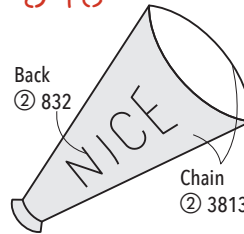

346

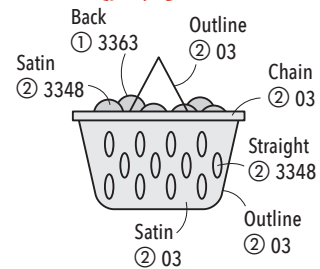

347

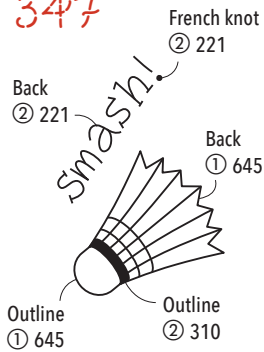

348

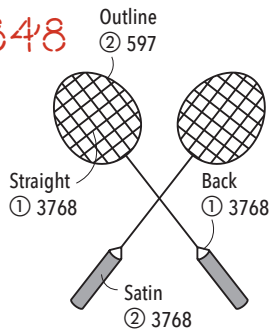

349

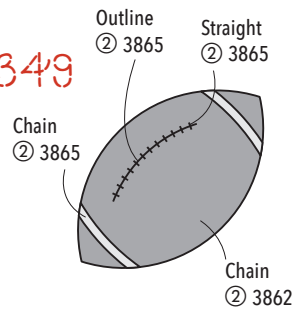

350

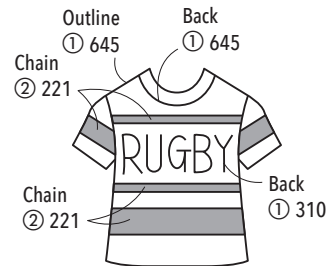

335

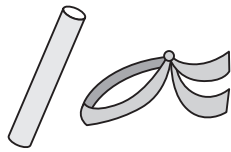

336

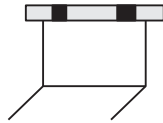

337

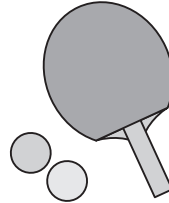

Let's
ping-pong 338

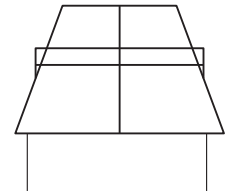

339



340



341

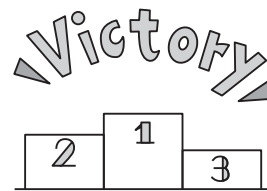

342



343

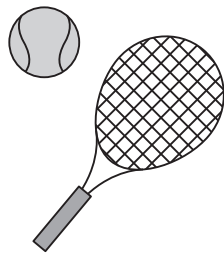

344

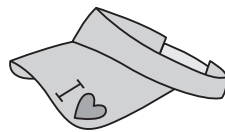

345

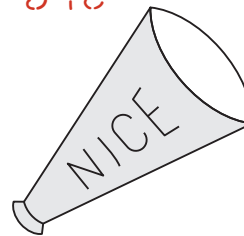

346

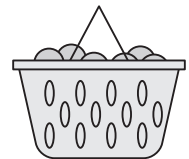

347

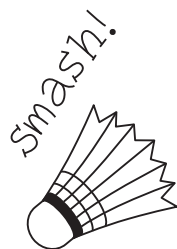

348

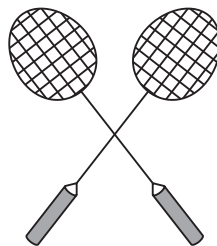

349

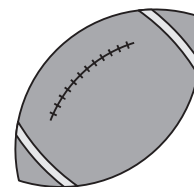

350



Hobbies & Activities

Photo: page 30

- The numbers represent the color numbers for DMC No. 25 embroidery floss
- The numbers in ○ represent the number of strands of thread
- Wrap French knots twice, unless otherwise noted

351

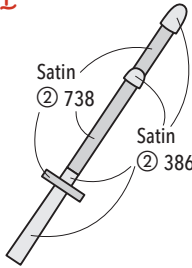

352

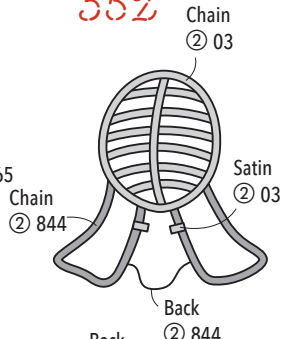

353

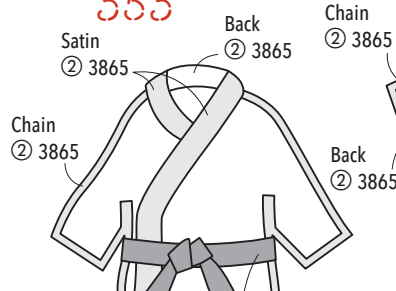

354

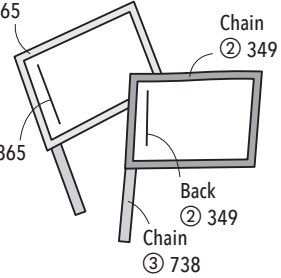

355

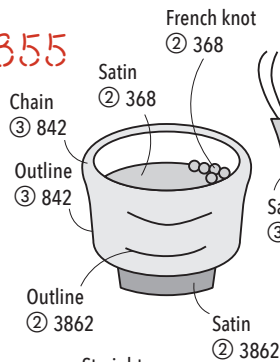

356

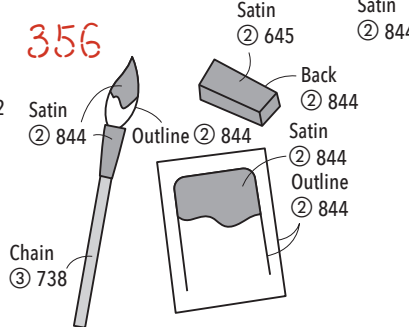

357

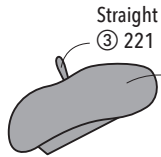
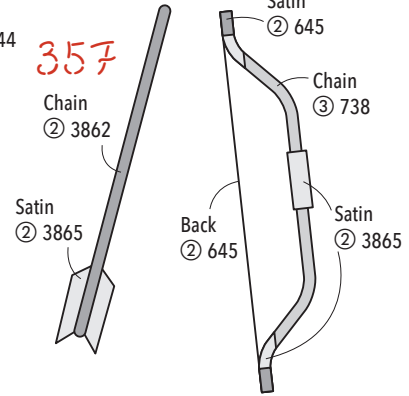

358

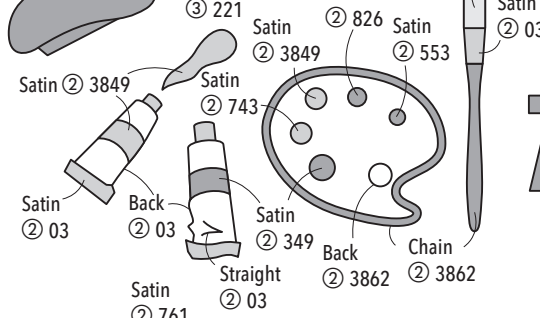

359

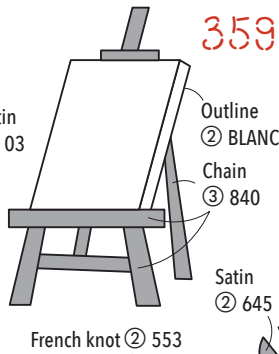

360

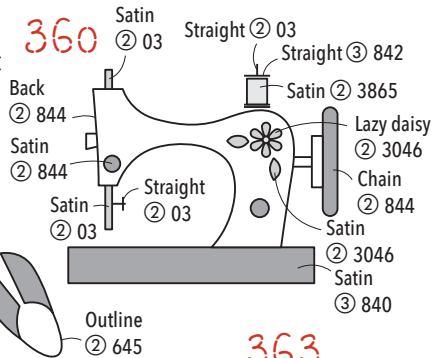

361

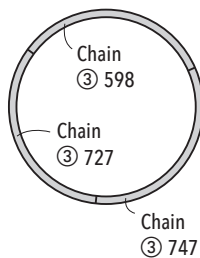
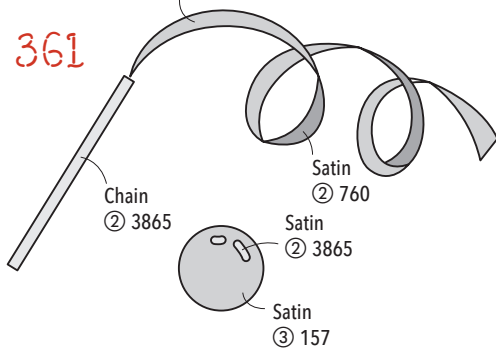

362

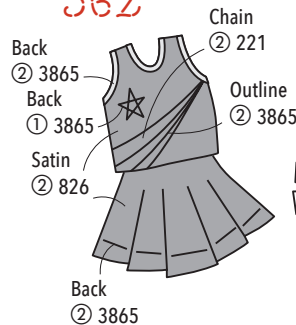

363

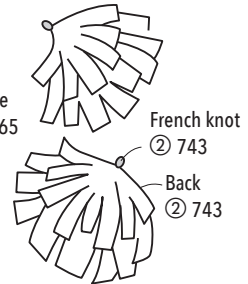

351

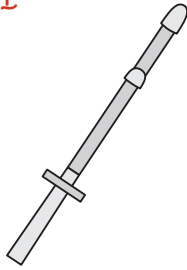

352

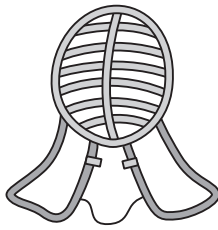

353



354

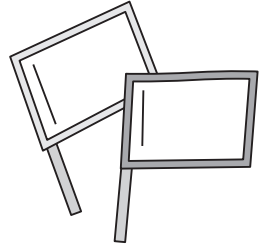

355



356

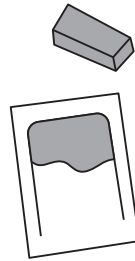
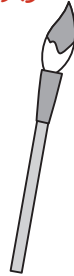

357

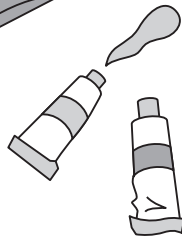
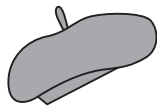
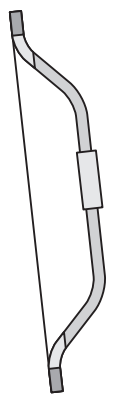
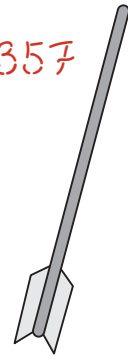

358

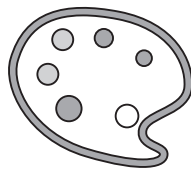

359

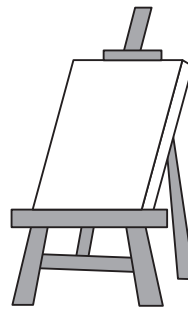

360

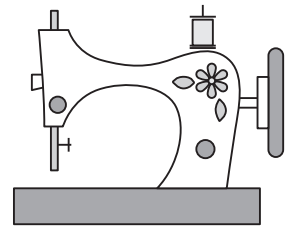

361

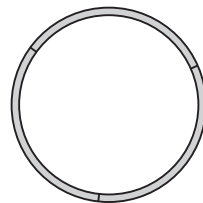
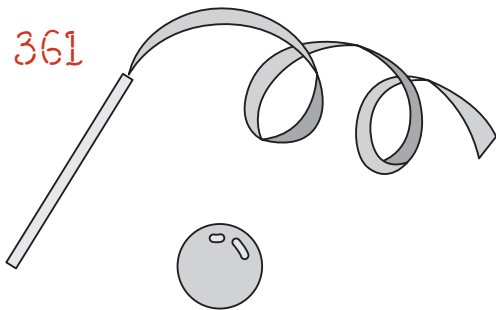

362



363

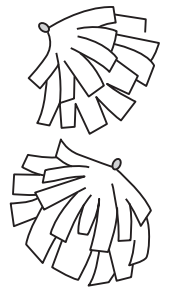

Hobbies & Activities

Photo: page 31

- The numbers represent the color numbers for DMC No. 25 embroidery floss
- The numbers in ○ represent the number of strands of thread
- Wrap French knots twice, unless otherwise noted

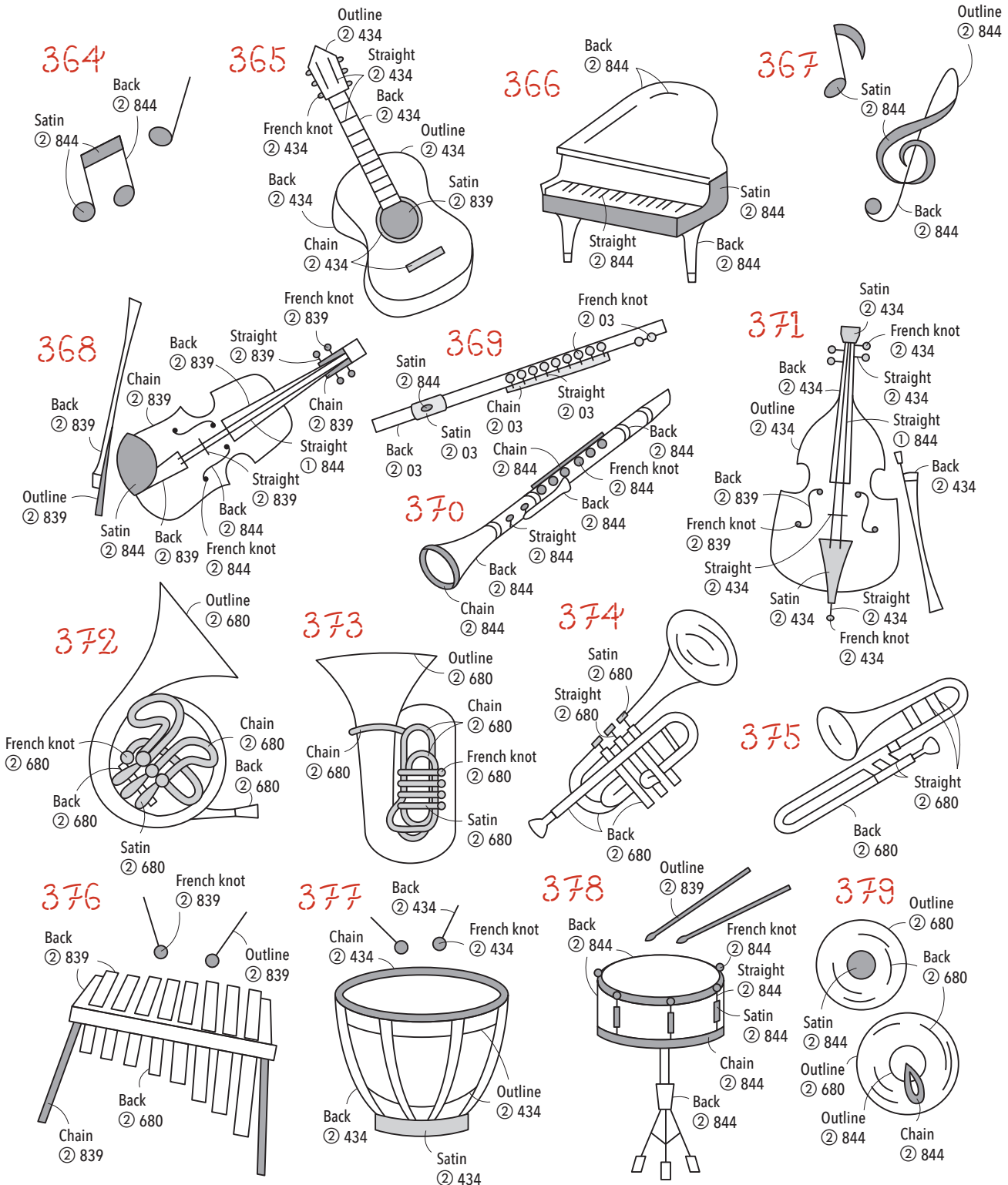

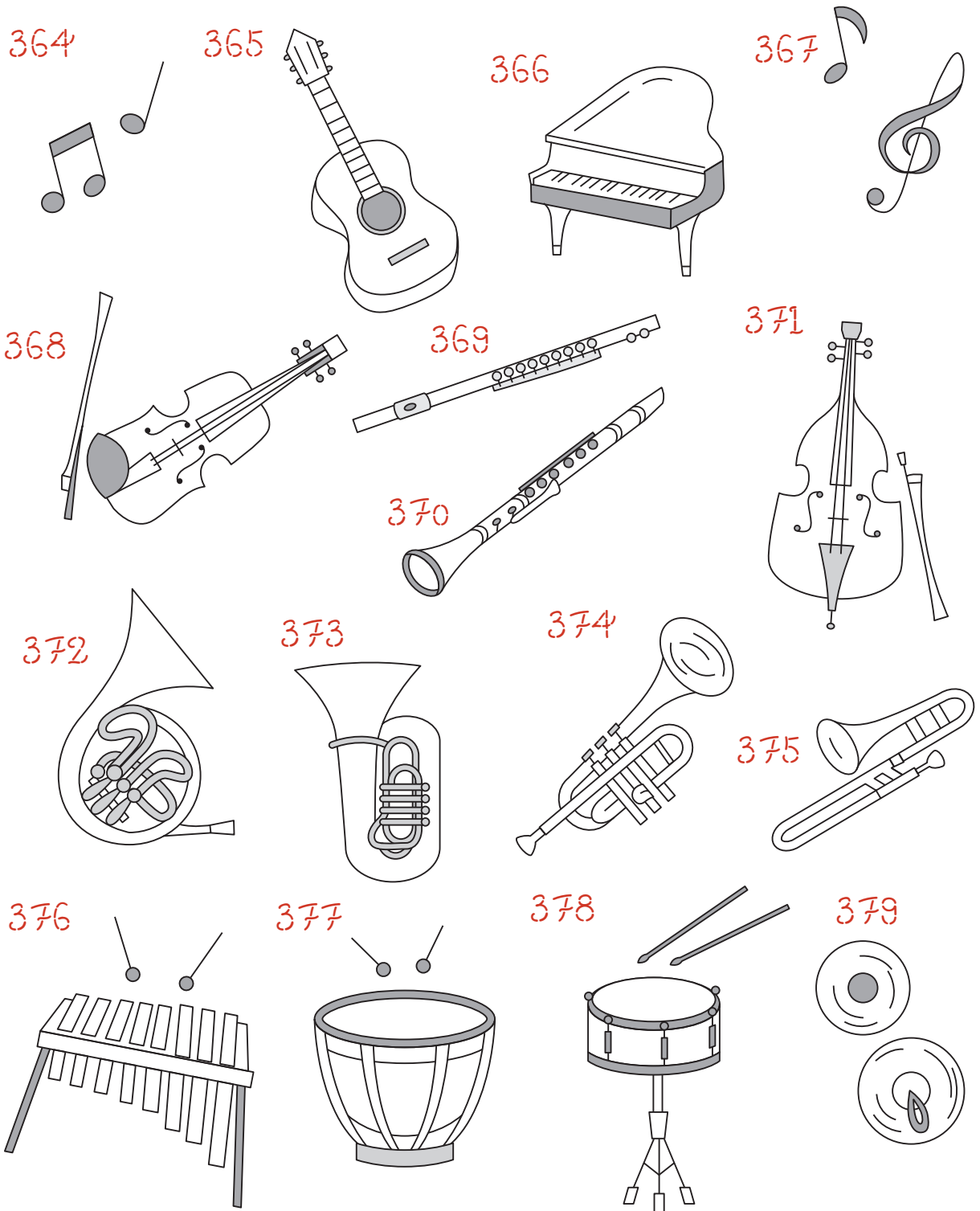

Border Designs

Photo: page 32

- The numbers represent the color numbers for DMC No. 25 embroidery floss
- The numbers in ○ represent the number of strands of thread
- Wrap French knots twice, unless otherwise noted

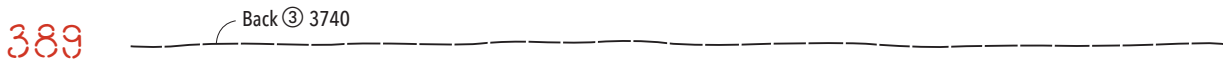
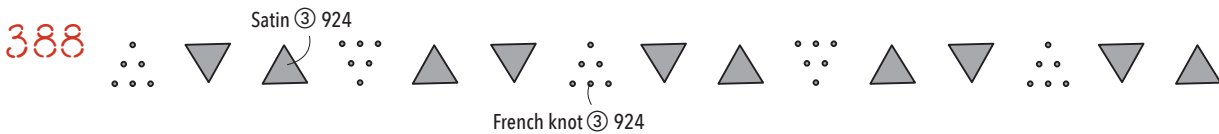
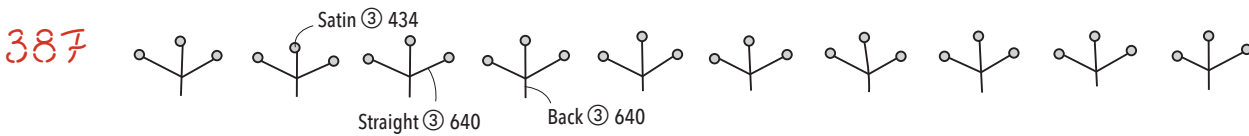
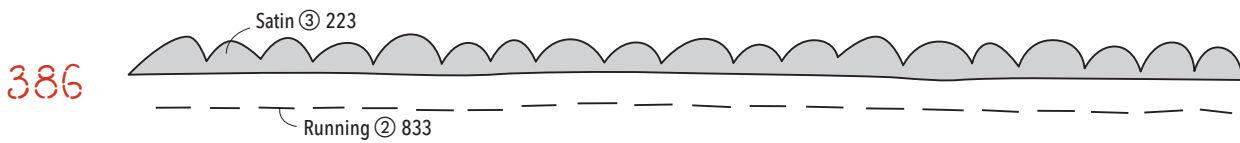
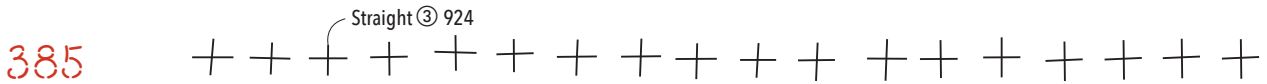
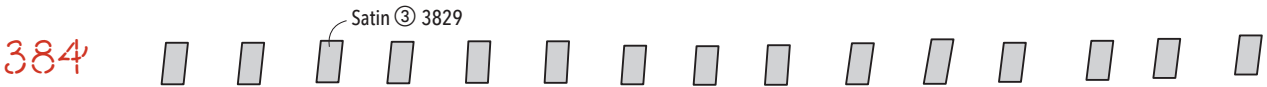
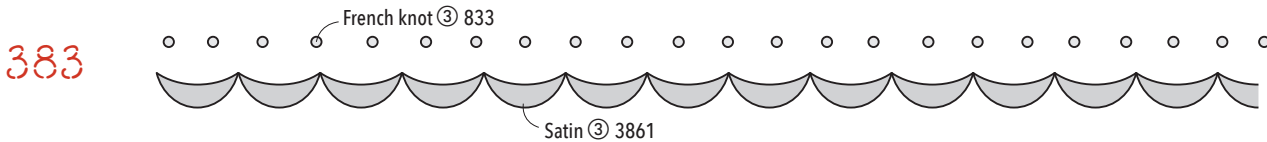
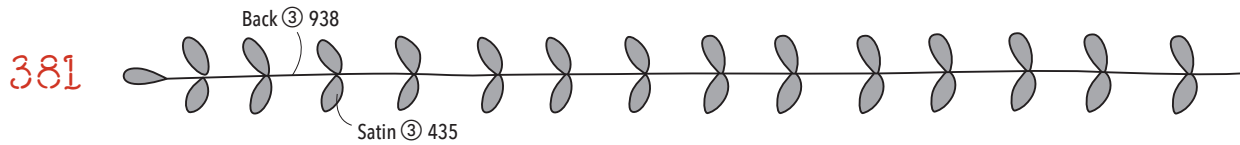

380



381

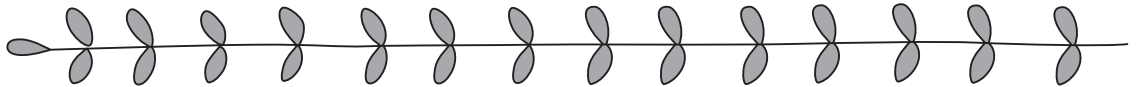

382



383



384



385

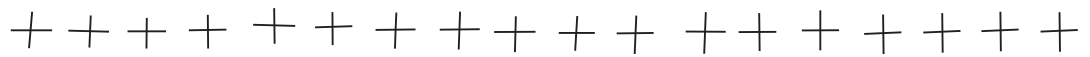

386



387

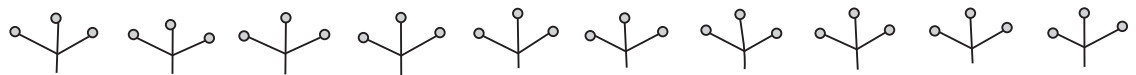

388



389



Border Designs

Photo: page 33

- The numbers represent the color numbers for DMC No. 25 embroidery floss
- The numbers in ○ represent the number of strands of thread
- Wrap French knots twice, unless otherwise noted

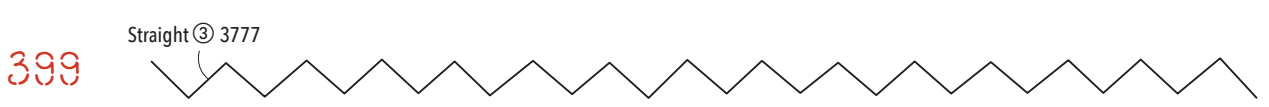
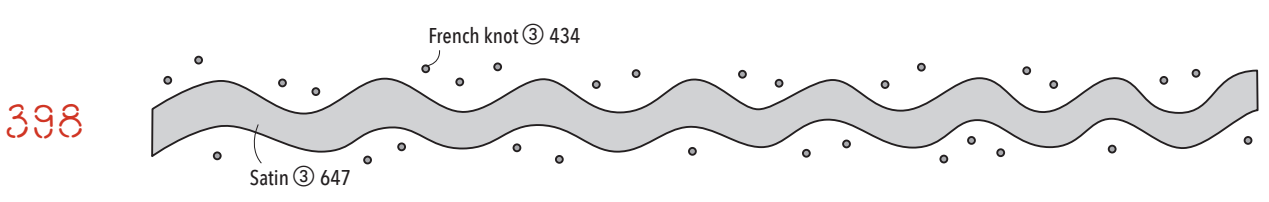
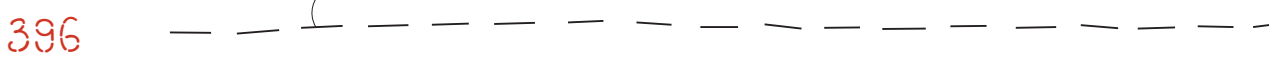
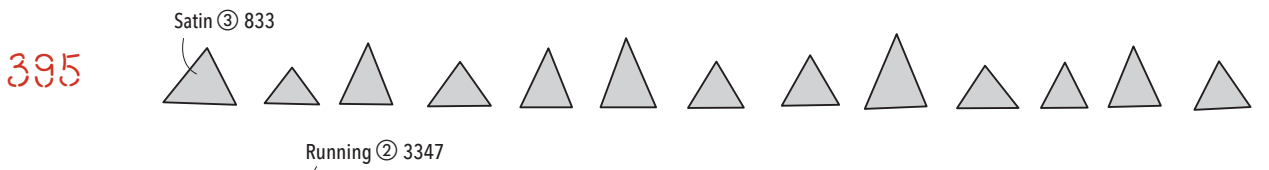
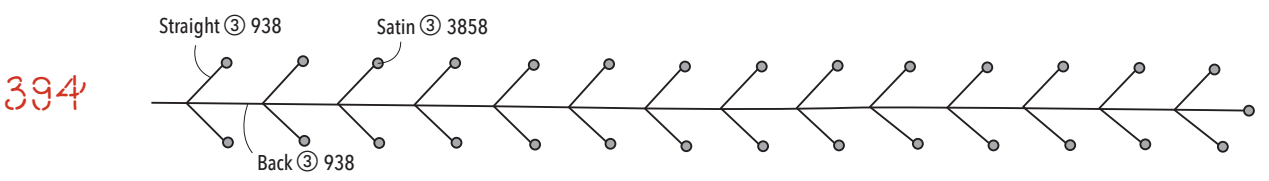
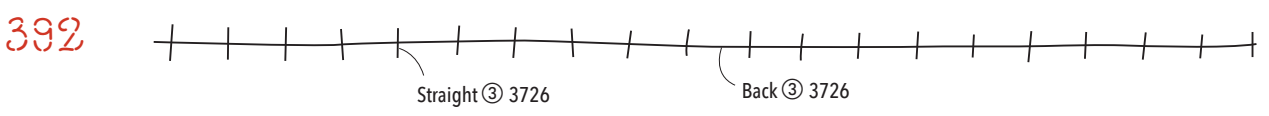
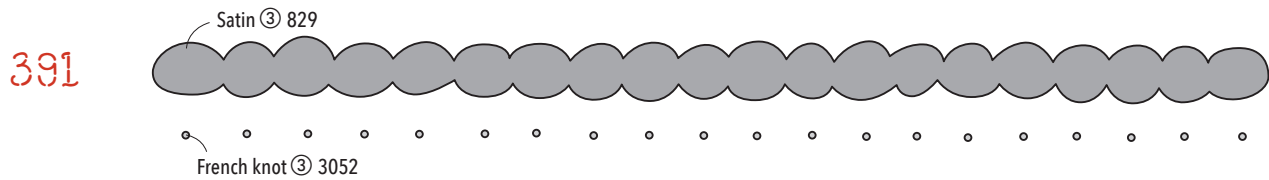

390



391

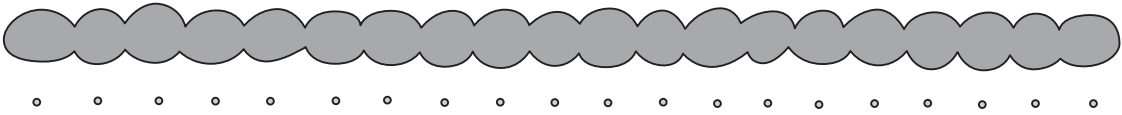

392

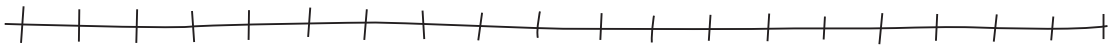

393



394

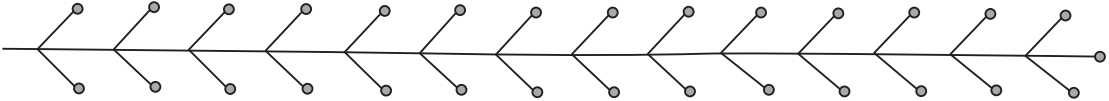

395



396



397



398

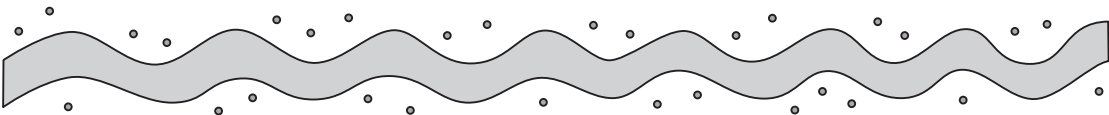

399

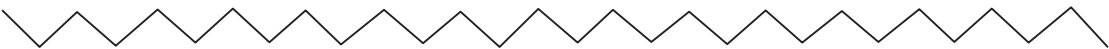

Flower Alphabets

Photo: page 34

- The numbers represent the color numbers for Cosmo No. 25 embroidery floss
- The numbers in ○ represent the number of strands of thread
- Wrap French knots twice, unless otherwise noted

400 Chain ② 117, Lazy daisy ② 233, Lazy daisy ② 272, Straight ① 858, Lazy daisy ② 380, French knot ② 151, Lazy daisy ② 813 (wrap once)

401 Straight ② 305, Lazy daisy ② 2317, Back ② 2317

402 Lazy daisy ② 631, Straight ② 342, Straight ② 631, Back ② 2323

403 Lazy daisy ② 336, Back ② 336, French knot ② 302 (wrap once), Lazy daisy ② 151, Straight ② 151

404 Chain ② 683, Lazy daisy ② 683, Back ② 925, Straight ② 925

405 Straight ② 307, Satin ② 834, French knot ② 2307 (wrap once), Chain ② 269, Straight ② 298

406 Satin ② 100, Lazy daisy ② 463, Satin ② 130, Outline ② 130, Back ② 2118, Outline ② 925

407 Satin ② 130, Lazy daisy ② 2323, Outline ② 272, Back ② 2118

408 Chain ② 2114, Outline ② 272

409 Satin ② 925, Back ② 673, French knot ② 764

410 Lazy daisy ③ 922, Chain ② 2307, Back ② 922, Lazy daisy ③ 925, Straight ② 922, Outline ② 117, Satin ③ 1000, French knot ② 701

411 Lazy daisy ② 318, Back ② 318

412 Lazy daisy ② 272, Back ② 384, Chain ② 117, Lazy daisy ② 9001

413 Lazy daisy ② 925, Chain ② 2307, Satin ② 1105, Satin ② 2323, Outline ② 631, Straight ② 925, Back ② 925

414 Straight ② 302, Lazy daisy ② 701, Chain ② 2307, Chain ② 130, French knot ② 384

415 Straight ③ 762, Lazy daisy ② 327, French knot ② 982, Outline ② 922, Lazy daisy ② 151

416 French knot ② 302, Lazy daisy ② 151, Back ① 2317, Lazy daisy ① 2317

417 Back ② 922, Straight ② 2307, Straight ② 327, French knot ② 2412 (wrap once), Straight ② 572, Back ② 922

418 Back ② 762, Back ② 922, Straight ② 762, Straight ② 922

419 Back ② 117, French knot ② 307, Lazy daisy ② 981A, Chain ② 117

420 Straight ③ 382, Lazy daisy ② 925, Back ② 925

421 French knot ② 302 (wrap once), Back ① 2317

422 Straight ② 305, Satin ② 108, Back ② 336, Straight ② 336

423 Straight ① 307, Lazy daisy ② 683, Back ② 683, Back ② 327

424 French knot ② 100, Outline ② 2317, Straight ② 2317

425 Chain ② 673, Lazy daisy ① 365, Lazy daisy ① 813, Lazy daisy ② 327, Chain ② 673, Back ② 327

400

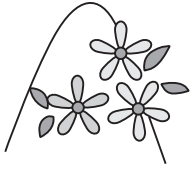

401



402



403



404

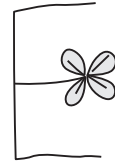

405

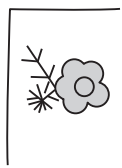

406



407



408



409

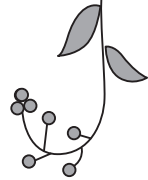

410

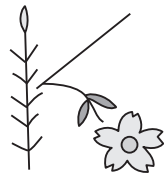

411



412



413

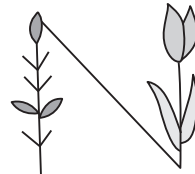

414

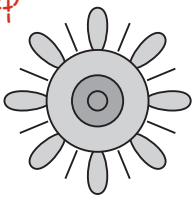

415



416



417

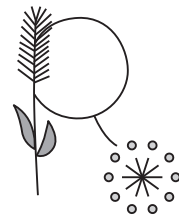

418



419

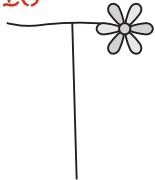

420



421



422

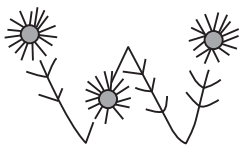

423



424

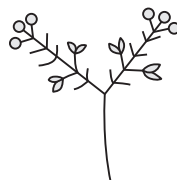

425

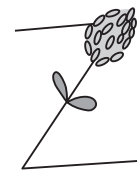

Flower Alphabets

Photo: page 35

- The numbers represent the color numbers for Cosmo No. 25 embroidery floss
- The numbers in ○ represent the number of strands of thread
- Wrap French knots twice, unless otherwise noted

426

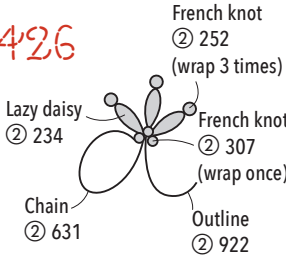

427

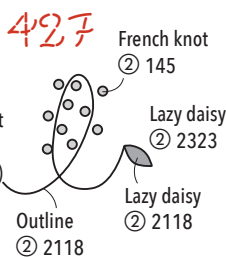

428

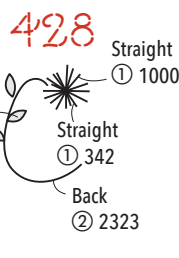

429

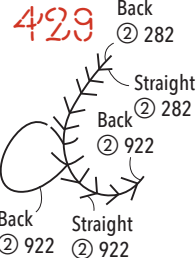

430

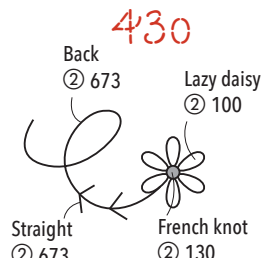

431

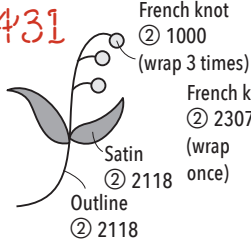

432

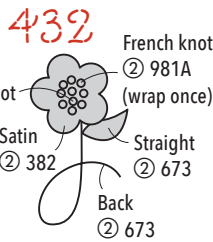

433

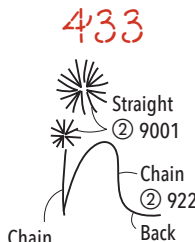

434

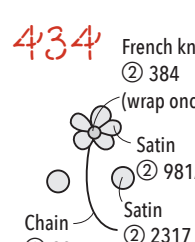

435

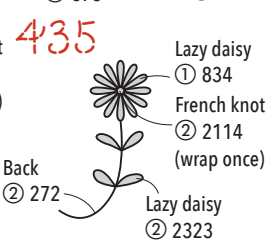

436

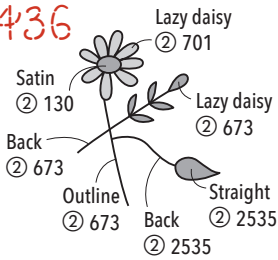

437

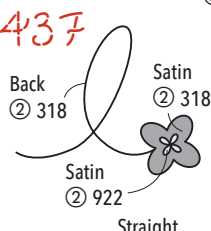

438

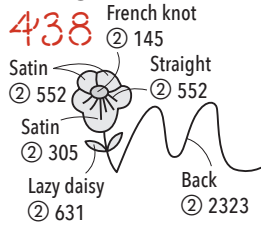

439

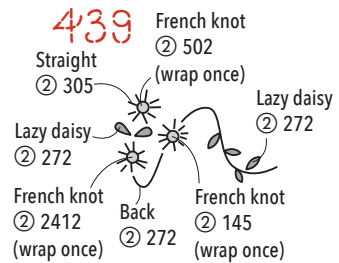

440

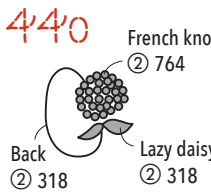

441

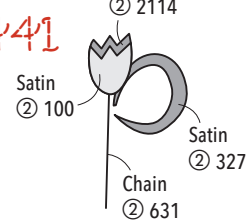

442

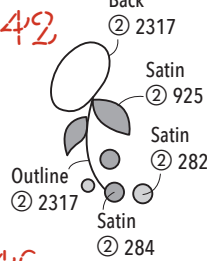

443

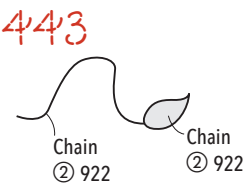

444

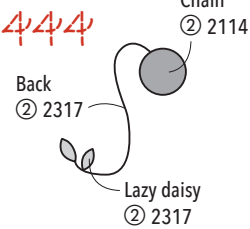

445

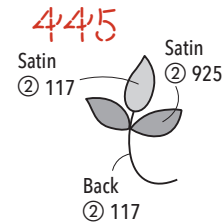

446

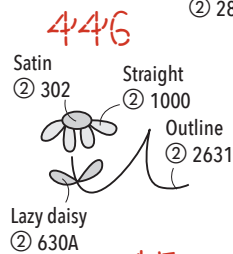

447

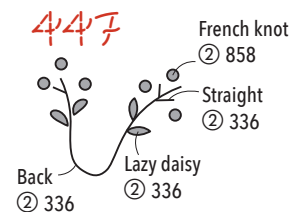

448

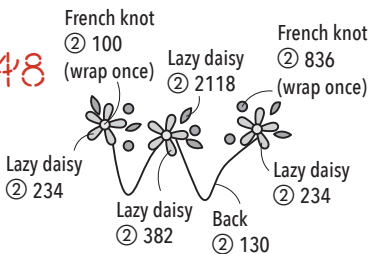

449

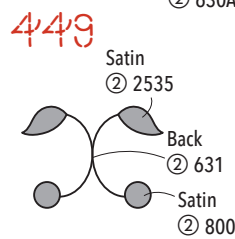

450

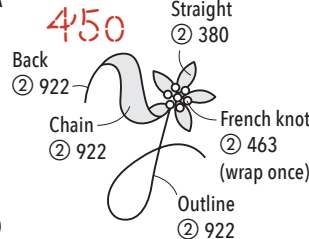

451

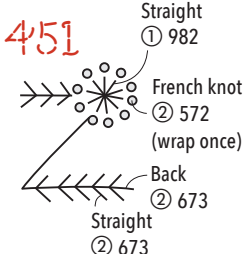

426



427



428



429



430



431



432



433



434



435



436



437



438



439



440



441

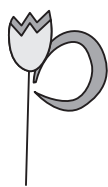

442



443



444

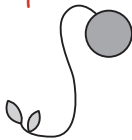

445



446



447



448



449

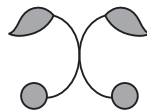

450



451

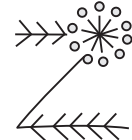

Food Alphabets

Photo: page 36

- Use Cosmo No. 25 embroidery floss in 310
- The numbers in ○ represent the number of strands of thread
- Wrap French knots twice, unless otherwise noted

452

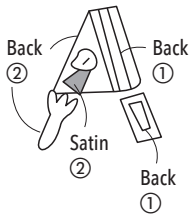

453

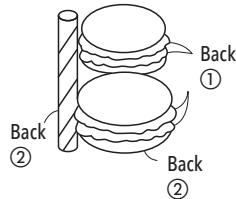

454

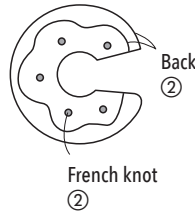

455



456

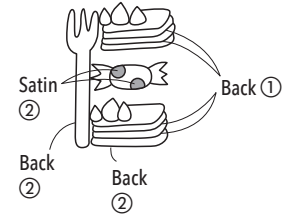

457

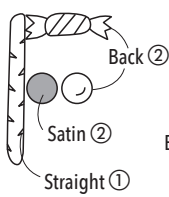

458

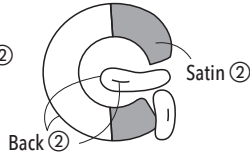

459

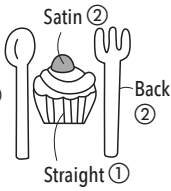

460

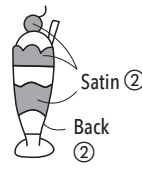

461

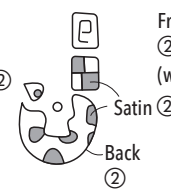

462



463

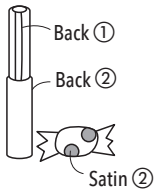

464

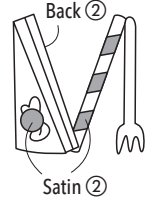

465

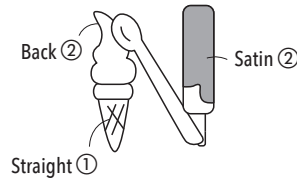

466

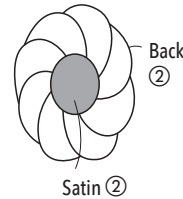

467

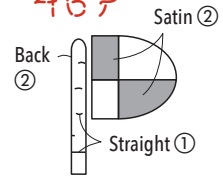

468

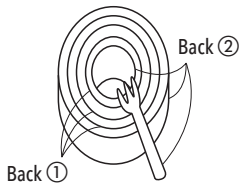

469

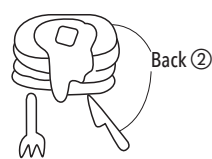

470



471

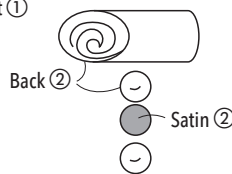

472

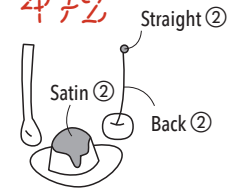

473

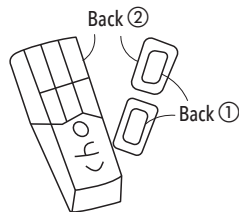

474

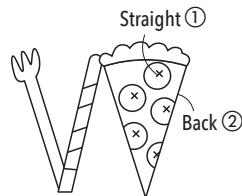

475



476

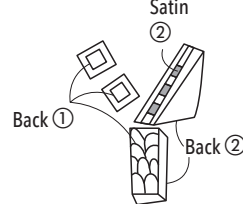

477

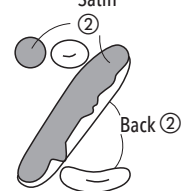

452

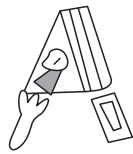

453

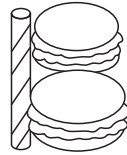

454

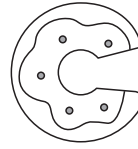

455



456

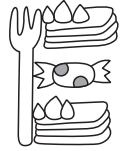

457

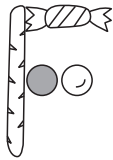

458



459



460



461



462



463

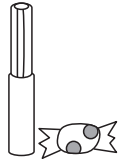

464

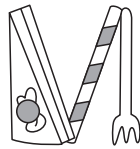

465

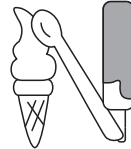

466

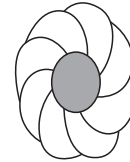

467

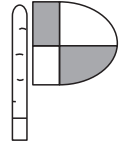

468



469

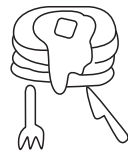

470



471

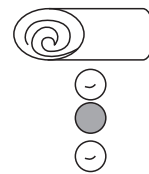

472

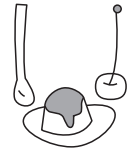

473

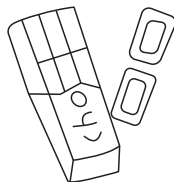

474

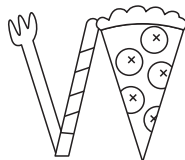

475

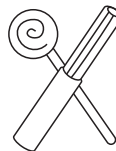

476

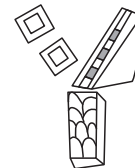

477

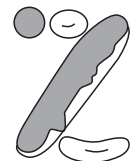

Food Alphabets

Photo: page 37

- Use Cosmo No. 25 embroidery floss in 236
- The numbers in ○ represent the number of strands of thread
- Wrap French knots twice, unless otherwise noted

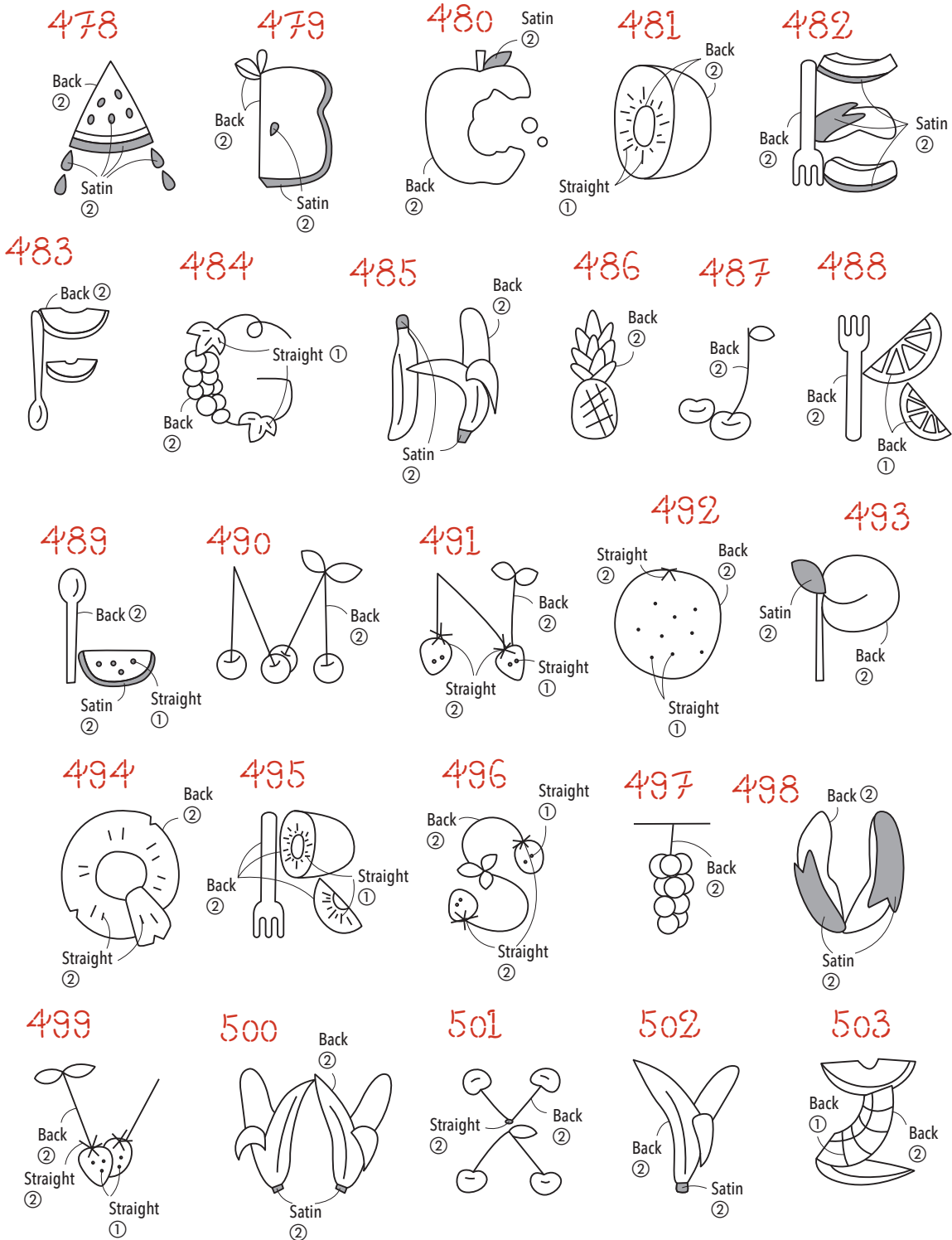

478

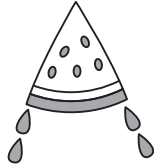

479

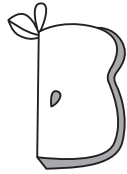

480



481



482

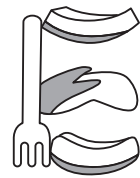

483



484

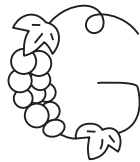

485



486



487



488



489



490

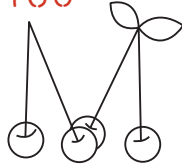

491

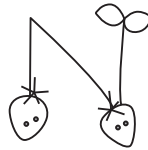

492

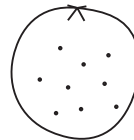

493

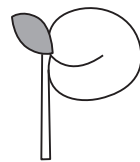

494

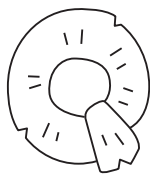

495

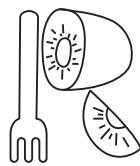

496



497

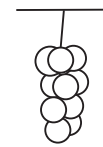

498



499



500



501

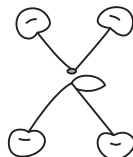

502



503



Letters & Numbers

- The numbers represent the color numbers for Cosmo No. 25 embroidery floss
- The numbers in ○ represent the number of strands of thread

Photo: page 38

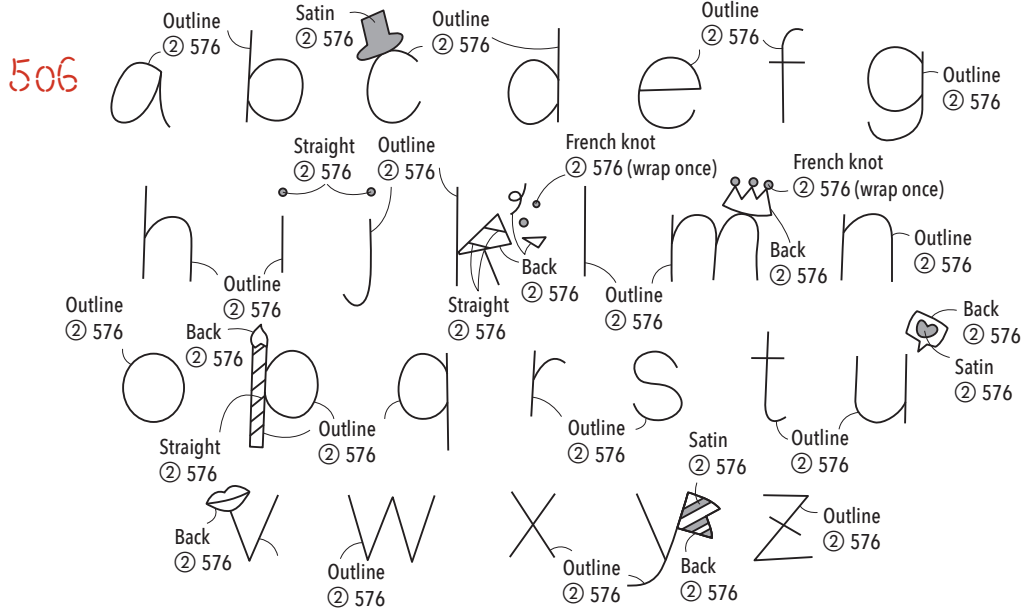
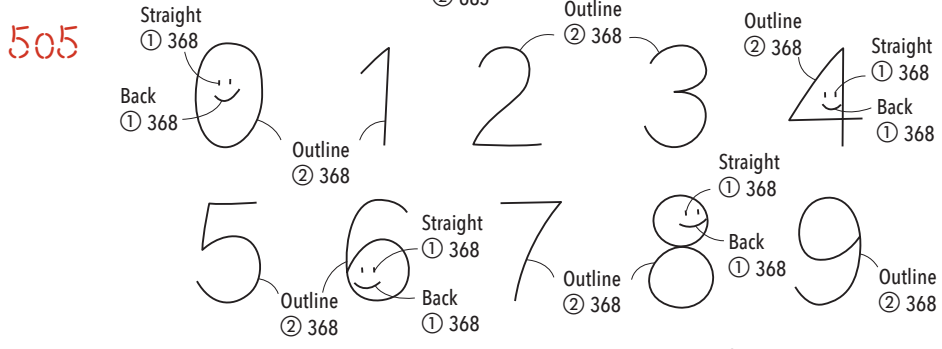
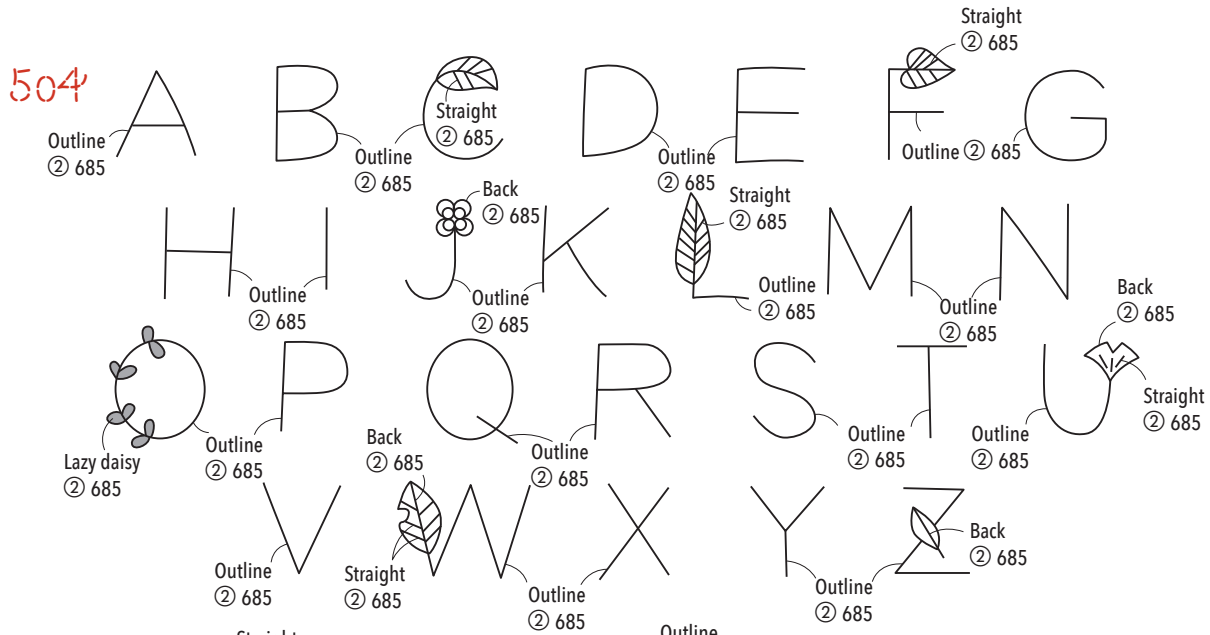

504



505

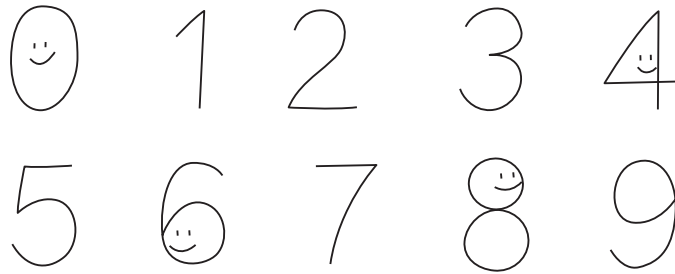

506

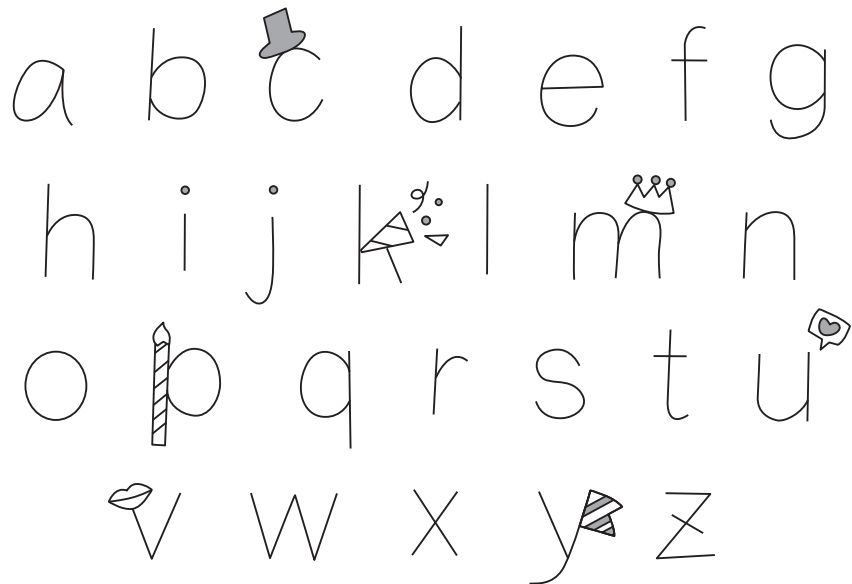

Childhood Favorites

Photo: page 39

- The numbers represent the color numbers for DMC No. 25 embroidery floss
- The numbers in ○ represent the number of strands of thread
- Wrap French knots twice, unless otherwise noted

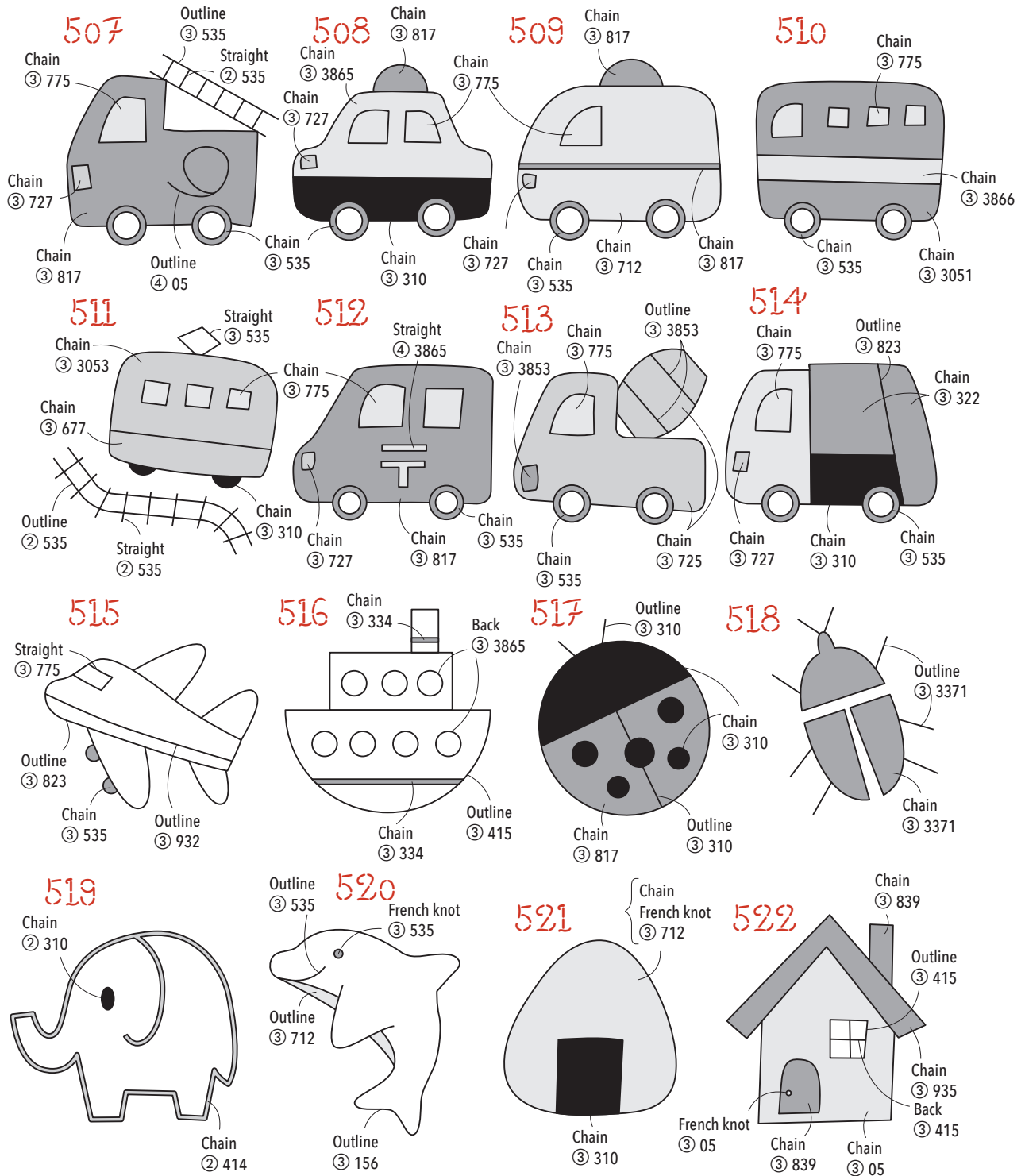

507

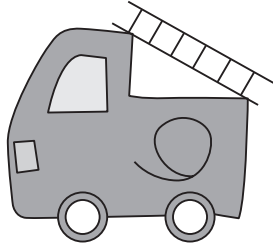

508

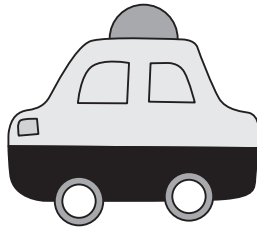

509

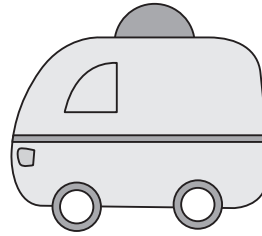

510

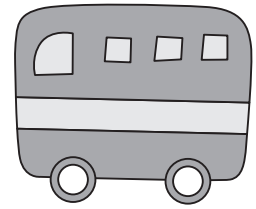

511

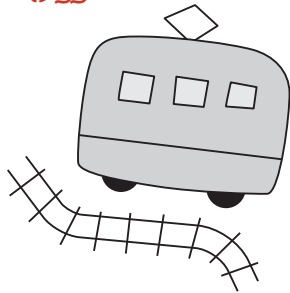

512

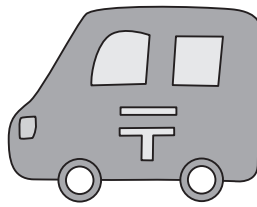

513

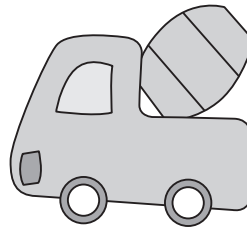

514

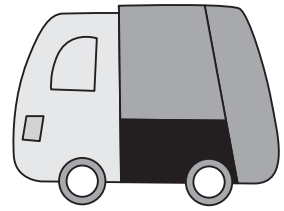

515

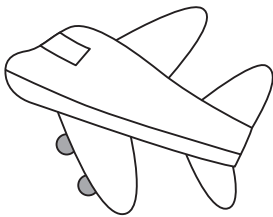

516

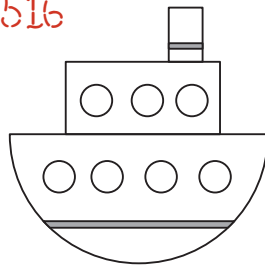

517

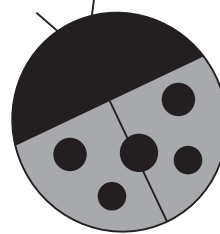

518

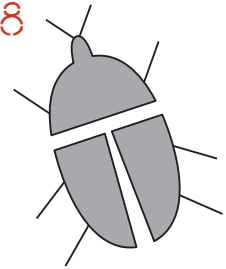

519

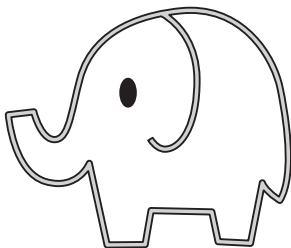

520

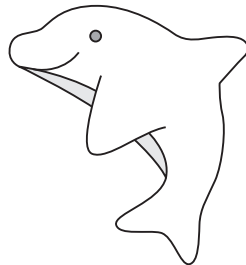

521

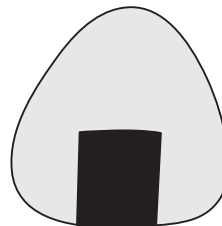

522



People & Things

Photo: page 40

- The numbers represent the color numbers for Olympus No. 25 embroidery floss
- The numbers in ○ represent the number of strands of thread
- Wrap French knots twice, unless otherwise noted

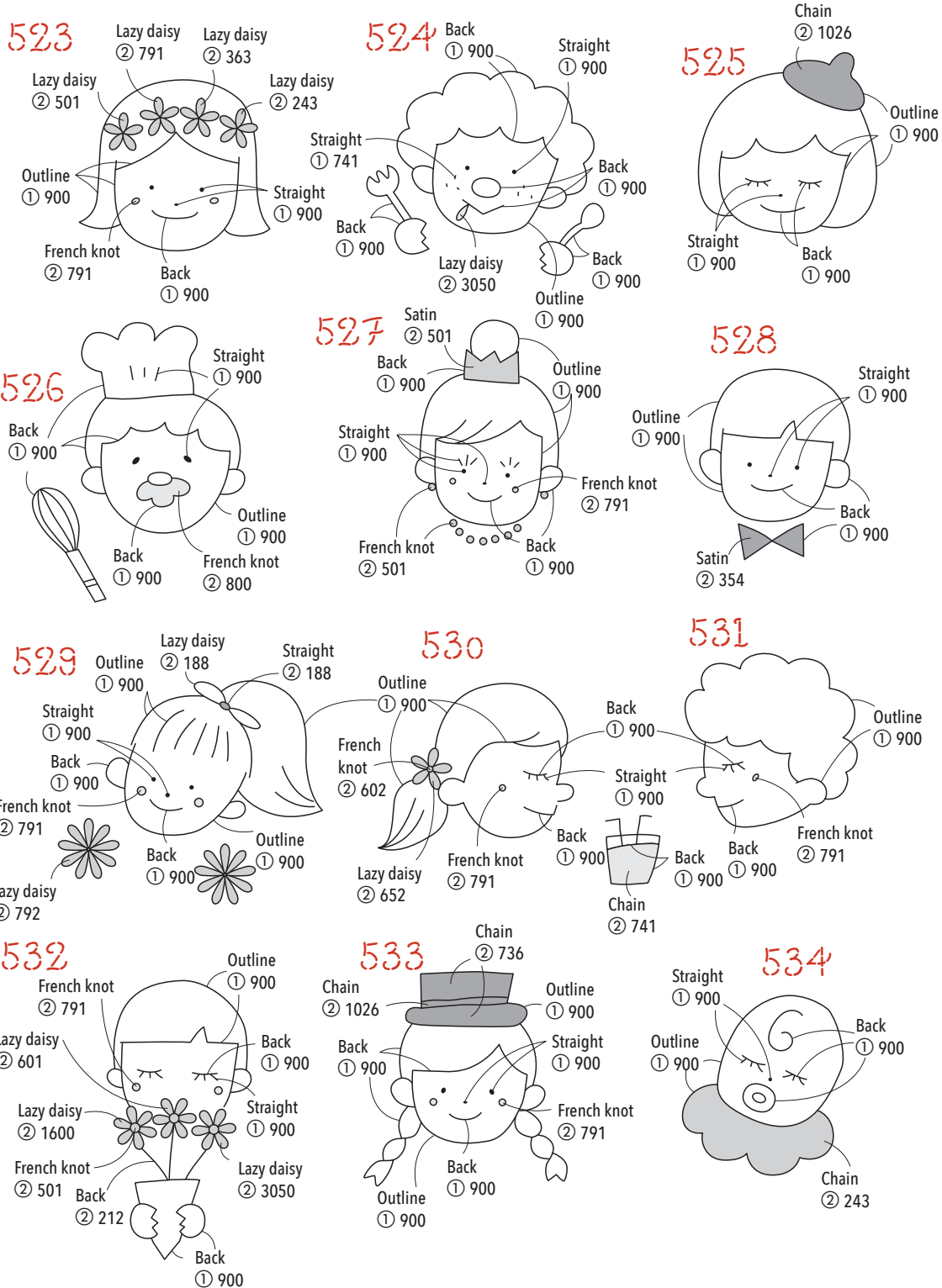

523

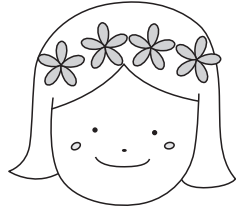

524

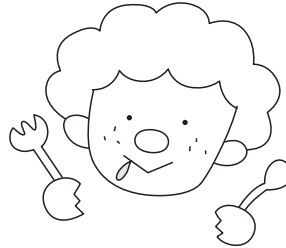

525



526



527



528

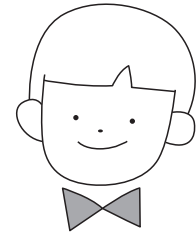

529

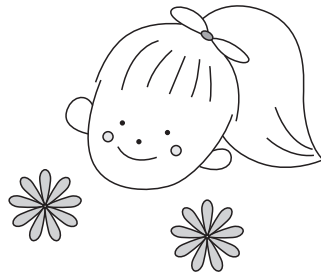

530

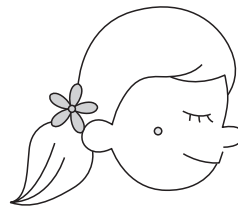

531



532

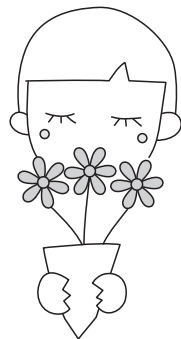

533

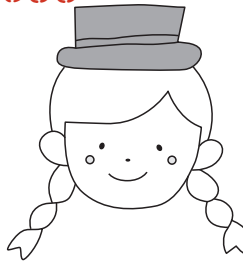

534



People & Things

Photo: page 41

- The numbers represent the color numbers for Olympus No. 25 embroidery floss
- The numbers in ○ represent the number of strands of thread
- Wrap French knots twice, unless otherwise noted

535

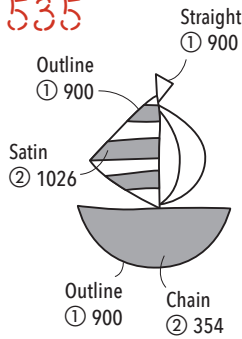

536

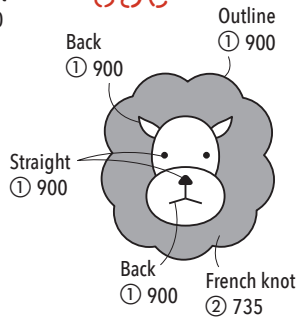

537

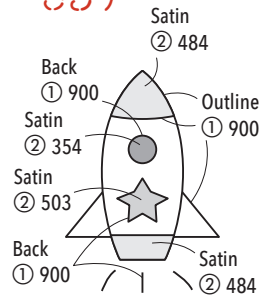

538

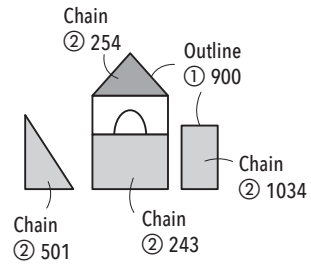

539

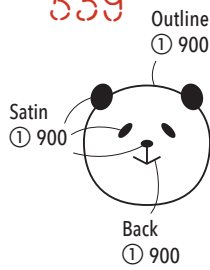

540

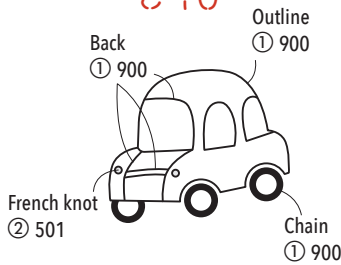

541

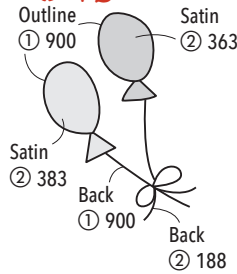

542

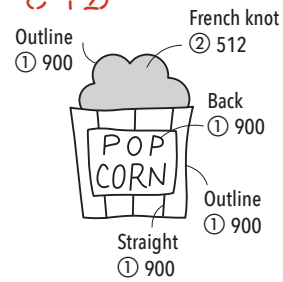

543

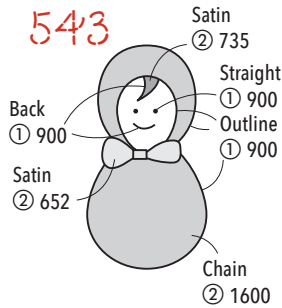

544

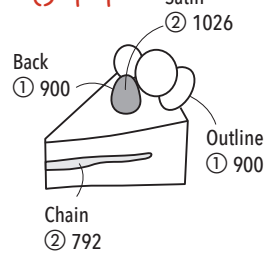

545

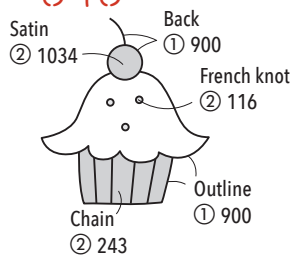

546

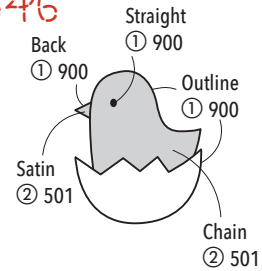

547

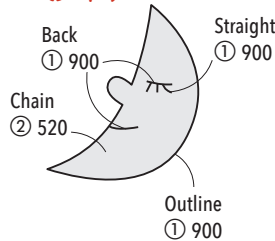

548

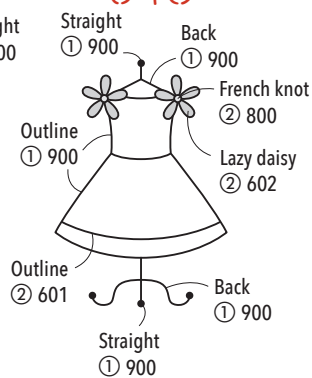

549

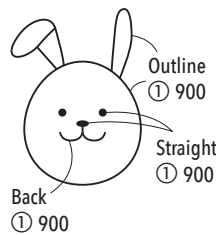

550

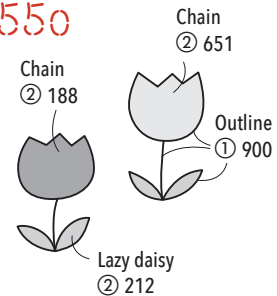

535



536



537

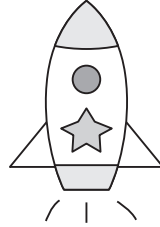

538

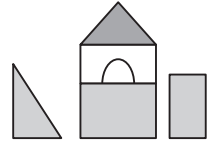

539



540



541

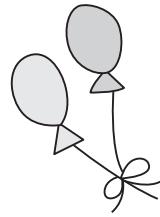

542



543



544

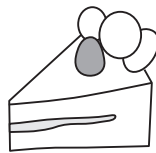

545

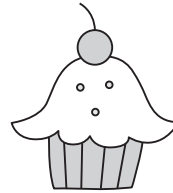

546

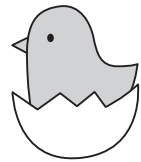

547

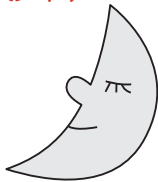

548



549



550

